

ICOM®

INSTRUCTION MANUAL

VHF MARINE TRANSCEIVER

IC-M402

(REMOTE-CONTROL MIC COMPATIBLE)

VHF MARINE TRANSCEIVER

IC-M402S

This device complies with Part 15 of the FCC rules. Operation is subject to the following two conditions: (1) This device may not cause harmful interference, and (2) this device must accept any interference received, including interference that may cause undesired operation.

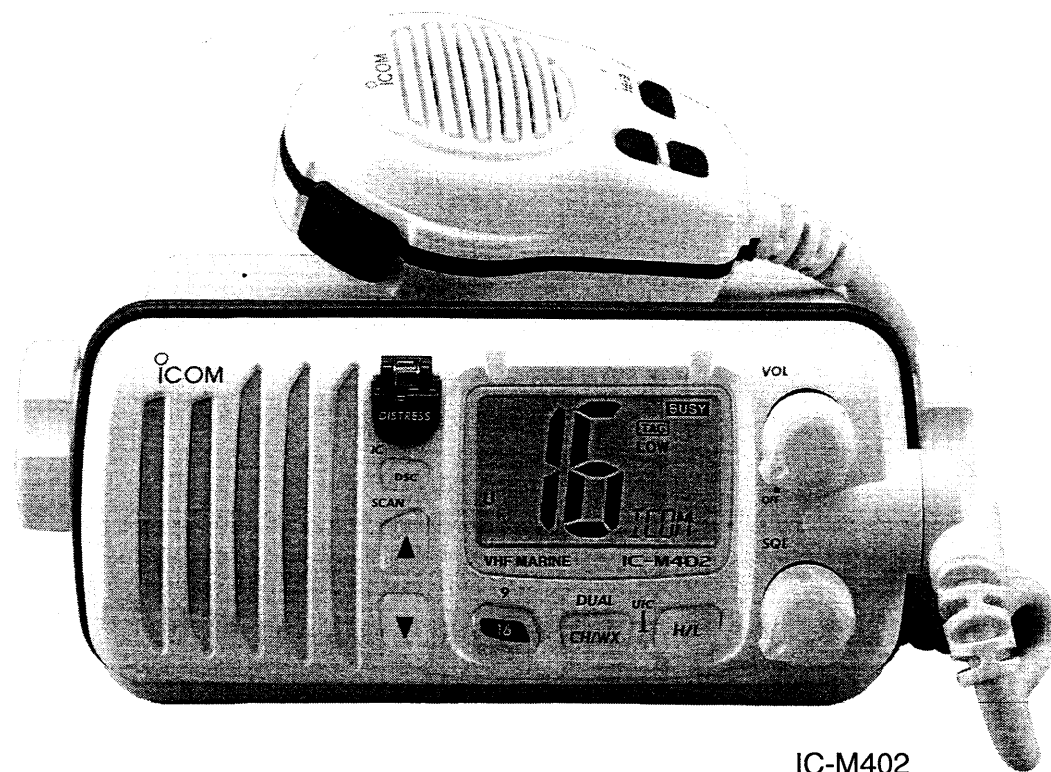

IC-M402

Icom Inc.

FOREWORD

Thank you for purchasing this Icom product. The IC-M402/M402S VHF MARINE TRANSCEIVERS are designed and built with Icom's superior technology and craftsmanship. With proper care, this product should provide you with years of trouble-free operation.

We want to take a couple of moments of your time to thank you for making your IC-M402/M402S your radio of choice, and hope you agree with Icom's philosophy of "technology first." Many hours of research and development went into the design of your IC-M402/M402S.

◆FEATURES

- *large 2-digit Ch with scrolling channel names*
- *Easy to hear speaker*
- *Built-in DSC capability that meets RTCM SC101*
- *Rugged waterproof construction*
- *Optional COMMANDMIC™ (IC-M402 only)*

NOTE

A WARNING STICKER is supplied with the transceiver. To comply with FCC regulations, this sticker must be affixed in such a location as to be readily seen from the operating controls of the radio like as follows. Make sure the chosen location is clean and dry before applying the sticker. (p. 22)

EXAMPLE

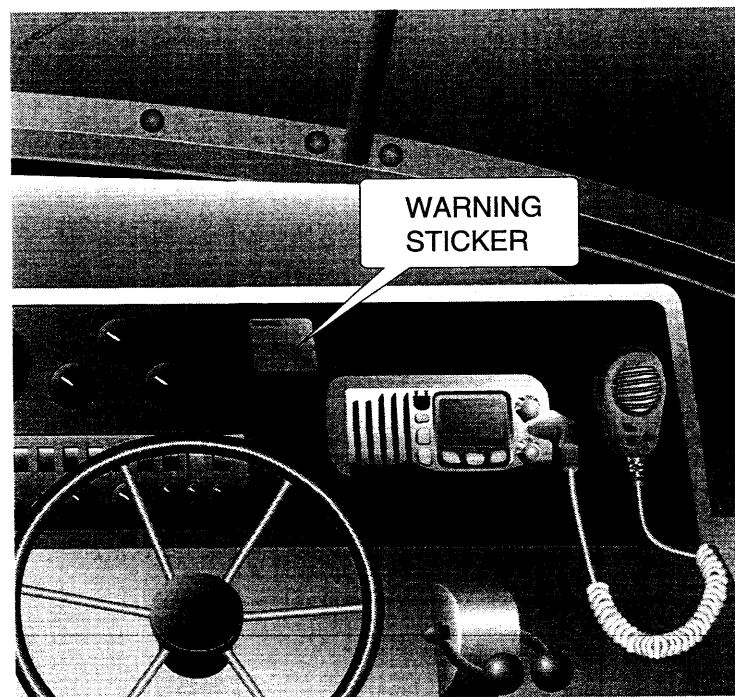

IMPORTANT

READ ALL INSTRUCTIONS carefully and completely before using the transceiver.

SAVE THIS INSTRUCTION MANUAL— This instruction manual contains important operating instructions for the IC-M402/M402S.

EXPLICIT DEFINITIONS

| WORD | DEFINITION |
|------------------|---|
| ⚠ WARNING | Personal injury, fire hazard or electric shock may occur. |
| CAUTION | Equipment damage may occur. |
| NOTE | If disregarded, inconvenience only. No risk of personal injury, fire or electric shock. |

IN CASE OF EMERGENCY

If your vessel requires assistance, contact other vessels and the Coast Guard by sending a distress call on Ch 16.

USING CHANNEL 16

DISTRESS CALL PROCEDURE

1. "MAYDAY MAYDAY MAYDAY."
2. "THIS IS" (name of vessel)
3. Your call sign or other indication of the vessel (AND 9-digit DSC ID if you have one).
4. "LOCATED AT" (your position)
5. The nature of the distress and assistance required.
6. Any other information which might facilitate the rescue.

Or, transmit your distress call using digital selective calling on Ch 70.

USING DIGITAL SELECTIVE CALLING (Ch 70)

DISTRESS CALL PROCEDURE

1. While lifting up the switch cover, push and hold [DISTRESS] for 5 sec. until you hear 5 short beeps change to one long beep.
2. Wait for an acknowledgment from a coast station.
 - Channel 16 is automatically selected.
3. Push and hold [PTT], then transmit the appropriate information as at left.

CAUTIONS

⚠ WARNING! NEVER connect the transceiver to an AC outlet. This may pose a fire hazard or result in an electric shock.

CAUTION: Changes or modifications to this device, not expressly approved by Icom Inc., could void your authority to operate this device under FCC regulations.

NEVER connect the transceiver to a power source of more than 16 V DC or use reverse polarity. This will ruin the transceiver.

NEVER cut the DC power cable between the DC plug and fuse holder. If an incorrect connection is made after cutting, the transceiver may be damaged.

NEVER place the transceiver where normal operation of the vehicle may be hindered or where it could cause bodily injury.

KEEP the transceiver at least 3.3 ft (1 m) away from the ship's navigation compass.

DO NOT use or place the transceiver in areas with temperatures below -4°F (-20°C) or above $+140^{\circ}\text{F}$ ($+60^{\circ}\text{C}$) or, in areas subject to direct sunlight, such as the dashboard.

AVOID the use of chemical agents such as benzine or alcohol when cleaning, as they may damage the transceiver surfaces.

BE CAREFUL! The transceiver rear panel will become hot when operating continuously for long periods.

Place the transceiver in a secure place to avoid inadvertent use by children.

BE CAREFUL! The transceiver and optional HM-127* employ waterproof construction, which corresponds to JIS waterproof specification, grade 7 (1 m/30 min.). However, once the transceiver or microphone has been dropped, waterproofing cannot be guaranteed due to the fact that the case may be cracked, or the waterproof seal damaged, etc.

*IC-M402 only.

Icom, Icom Inc. and the  logo are registered trademarks of Icom Incorporated (Japan) in the United States, the United Kingdom, Germany, France, Spain, Russia and/or other countries.

RADIO OPERATOR WARNING



WARNING

Icom requires the radio operator to meet the FCC Requirements for Radio Frequency Exposure. An omnidirectional antenna with gain not greater than 9 dBi must be mounted a minimum of 5 meters (measured from the lowest point of the antenna) vertically above the main deck and all possible personnel. This is the minimum safe separation distance estimated to meet all RF exposure compliance requirements. This 5 meter distance is based on the FCC Safe Maximum Permissible Exposure (MPE) distance of 3 meters added to the height of an adult (2 meters) and is appropriate for all vessels.

For watercraft without suitable structures, the antenna must be mounted so as to maintain a minimum of 1 meter vertically between the antenna, (measured from the lowest point of the antenna), to the heads of all persons AND all persons must stay outside of the 3 meter MPE radius.

Do not transmit with radio and antenna when persons are within the MPE radius of the antenna, unless such persons (such as driver or radio operator) are shielded from antenna field by a grounded metallic barrier. The MPE Radius is the minimum distance from the antenna axis that person should maintain in order to avoid RF exposure higher than the allowable MPE level set by FCC.

FAILURE TO OBSERVE THESE LIMITS MAY ALLOW THOSE WITHIN THE MPE RADIUS TO EXPERIENCE RF RADIATION ABSORPTION WHICH EXCEEDS THE FCC MAXIMUM PERMISSIBLE EXPOSURE (MPE) LIMIT. IT IS THE RESPONSIBILITY OF THE RADIO OPERATOR TO ENSURE THAT THE MAXIMUM PERMISSIBLE EXPOSURE LIMITS ARE OBSERVED AT ALL TIMES DURING RADIO TRANSMISSION. THE RADIO OPERATOR IS TO ENSURE THAT NO BYSTANDERS COME WITHIN THE RADIUS OF THE MAXIMUM PERMISSIBLE EXPOSURE LIMITS.

Determining MPE Radius

THE MAXIMUM PERMISSIBLE EXPOSURE (MPE) RADIUS HAS BEEN ESTIMATED TO BE A RADIUS OF ABOUT 3M PER OET BULLETIN 65 OF THE FCC. THIS ESTIMATE IS MADE ASSUMING THE MAXIMUM POWER OF THE RADIO AND ANTENNAS WITH A MAXIMUM GAIN OF 9dBi ARE USED FOR A SHIP MOUNTED SYSTEM.

TABLE OF CONTENTS

| | | | | | |
|------------------------------------|--------------|---|--------------|---------------------------------------|--------------|
| FOREWORD | i | ■ MMSI code check | 11 | ■ Monitor function | 32 |
| NOTE | i | ■ Position indication | 11 | ■ Call channel programming | 32 |
| IMPORTANT | ii | ■ Distress call | 12 | ■ Starting a scan | 33 |
| EXPLICIT DEFINITIONS | ii | ■ Transmitting DSC calls | 13 | ■ Setting tag channels | 33 |
| IN CASE OF EMERGENCY | ii | ■ DSC individual ID | 16 | ■ Dualwatch/Tri-watch operation | 33 |
| CAUTIONS | iii | ■ Receiving DSC calls | 16 | ■ Set mode programming | 34 |
| RADIO OPERATOR WARNING | iv | 7 INTERCOM OPERATION | | ■ Intercom operation | 34 |
| TABLE OF CONTENTS | v | (IC-M402 only) | 19 | ■ Channel names | 35 |
| | | ■ Intercom operation | 19 | ■ HM-127 supplied accessories | 35 |
| 1 OPERATING RULES | 1 | 8 SET MODE | 20-21 | ■ Installation | 36-37 |
| 2 PANEL DESCRIPTION | 2-4 | ■ Set mode programming | 20 | 11 TROUBLESHOOTING | 38 |
| ■ Panel description | 2 | ■ Set mode items | 20 | 12 CHANNEL LIST | 39 |
| ■ Function display | 3 | 9 CONNECTIONS AND | | 13 SPECIFICATIONS | 40-41 |
| ■ Microphone | 4 | MAINTENANCE | 22-25 | ■ Specifications | 40 |
| 3 BASIC OPERATION | 5-7 | ■ Supplied accessories | 22 | ■ Dimensions | 41 |
| ■ Channel selection | 5 | ■ Antenna | 22 | 14 MB-69/HM-127 TEMPLATE | 42 |
| ■ Microphone lock function | 6 | ■ Fuse replacement | 22 | 15 OPTIONS | 44 |
| ■ Receiving and transmitting | 6 | ■ Cleaning | 22 | | |
| ■ Call channel programming | 7 | ■ Connections | 23 | | |
| ■ Channel names | 7 | ■ Mounting the transceiver | 24 | | |
| 4 DUALWATCH/TRI-WATCH | 8 | ■ MB-69 mounting bracket (Option) | 25 | | |
| ■ Description | 8 | 10 HM-127 REMOTE-CONTROL | | | |
| ■ Operation | 8 | MICROPHONE (IC-M402 only) | 26-37 | | |
| 5 SCAN OPERATIONS | 9-10 | ■ Panel description | 26 | | |
| ■ Setting tag channels | 9 | ■ Function display | 28 | | |
| ■ Starting a scan | 9 | ■ Receiving and transmitting | 29 | | |
| ■ Scan types | 10 | ■ Lock functions | 30 | | |
| 6 DSC OPERATION | 11-18 | ■ Channel selection | 31 | | |
| ■ MMSI code programming | 11 | ■ Display backlighting | 32 | | |

■ Channel selection

◇ PRIORITIES

- Read all rules and regulations pertaining to priorities and keep an up-to-date copy handy. Safety and distress calls take priority over all others.
- You should monitor Ch 16 when you are not operating on another channel.
- False or fraudulent distress signals are prohibited and punishable by law.

◇ PRIVACY

- Information overheard but not intended for you cannot lawfully be used in any way.
- Indecent or profane language is prohibited.

◇ RADIO LICENSES

(1) SHIP STATION LICENSE

In some countries, you must have a current radio station license before using the transceiver.

Inquire through your dealer or the appropriate government agency for a Ship-Radiotelephone license application. This government-issued license states the call sign which is your craft's identification for radio purposes.

(2) OPERATOR'S LICENSE

A Restricted Radiotelephone Operator Permit is the license most often held by small vessel radio operators when a radio is not required for safety purposes.

The Restricted Radiotelephone Operator Permit must be posted or kept with the operator.

However, non-licensed individuals may talk over a transceiver if a licensed operator starts, supervises, ends the call and makes the necessary log entries.

Keep a copy of the current government rules and regulations handy.

Radio license for boaters (U.S.A. only)

The Telecommunications Act of 1996 permits recreational boaters to have and use a VHF marine radio, EPIRB, and marine radar without having an FCC ship station license.

Boaters travelling on international voyages, having an HF single sideband radiotelephone or marine satellite terminal, or required to carry a marine radio under any other regulation must still carry an FCC ship station license. For further information, see the FCC Ship Radio Stations Fact Sheet.

■ Panel description

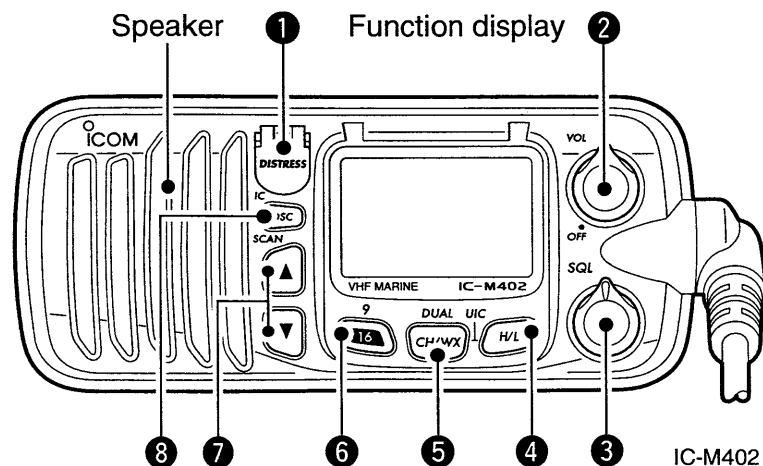

1 DISTRESS SWITCH [DISTRESS]

Transmits distress call when pushed for 5 sec. (p. 12)

2 POWER / VOLUME CONTROL [VOL]

Turns power ON and OFF and adjusts the audio level. (p. 6)

3 SQUELCH CONTROL [SQL]

Sets the squelch threshold level. (p. 6)

4 TRANSMIT POWER SWITCH [H/L]

➔ Toggles high and low power when pushed. (p. 6)

- Some channels are set to low power only.

➔ While pushing this switch, other switches perform secondary functions.

5 CHANNEL SWITCH [CH/WX•DUAL]

➔ Selects and toggles the regular channels and weather channel when pushed momentarily. (p. 5)

➔ While push and hold [H/L] push [CH/WX•DUAL] to selects one of 3 regular channels in sequence. (p. 5)

- International, U.S.A. and Canadian channels are available for regular channels.

➔ Starts dualwatch or tri-watch when pushed for 1 sec. (p. 8)

➔ Stops dualwatch or tri-watch when either is activated.

6 CHANNEL 16/CALL CHANNEL SWITCH [16•9]

➔ Selects Ch 16 when pushed. (p. 5)

➔ Selects call channel when pushed for 1 sec. (p. 5)

- “CALL” appears when call channel is selected.

➔ Push for 3 sec. to enter call channel programming condition when call channel is selected. (p. 7)

➔ While push and hold [H/L] push [16•9] to enter memory name programming condition. (p. 7)

➔ While turning power ON push [16•9] to enter set mode. (p. 20)

7 CHANNEL UP / DOWN SWITCHES [▲/▼•SCAN]

➔ Push to select the operating channels, set mode contents, etc. (p. 6)

➔ While push and hold [H/L] push [▲]/[▼] to adjust the brightness of the LCD and switch backlight.

➔ Push for 3 sec. to enter call channel programming condition when call channel is selected. (p. 7)

➔ Push [▲] or [▼] for 1sec. to start/stop scanning. (p. 10)

➔ Push [▲] and [▼] for 1sec. to toggle the tag setting for the displayed channel. (p. 10)

8 DSC/INTERCOM SWITCH [DSC/IC] ([DSC] for IC-M402S)

➔ Selects the DSC menu when pushed. (p. 11)

➔ While push and hold [H/L] push [DSC] for 1 sec. to show current position and time. (p. 11)

➔ Push [DSC] for 1 sec. to enter intercom mode. (IC-M402 only, p. 19)

■ Function display

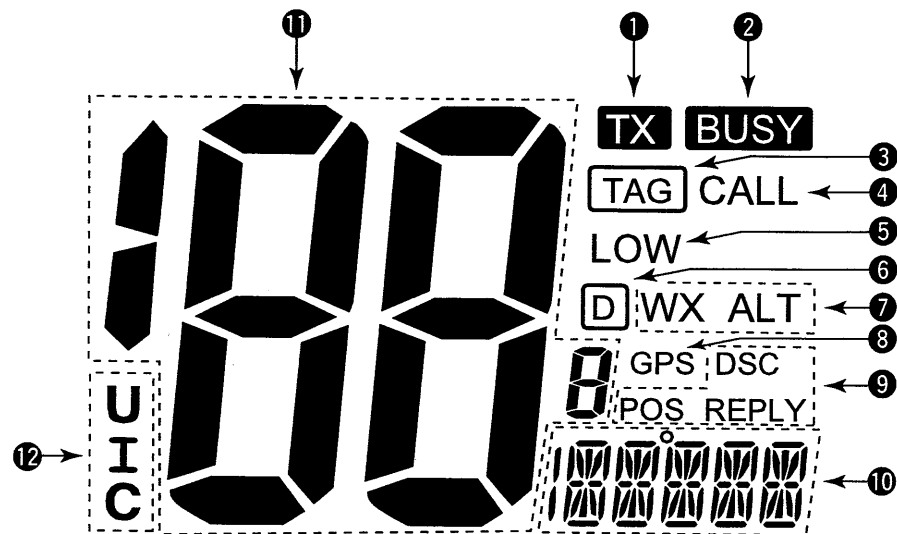

① TRANSMIT INDICATOR (p. 6)

“TX” appears while transmitting.

② BUSY INDICATOR (p. 6)

“BUSY” appears when receiving a signal or when the squelch opens.

③ TAG CHANNEL INDICATOR (p. 9)

Appears when a tag channel is selected.

④ CALL CHANNEL INDICATOR

“CALL” appears when the call channel is selected. (p. 5)

⑤ LOW POWER INDICATOR (p. 6)

“LOW” appears when low power is selected.

⑥ DUPLEX INDICATOR (p. 5)

“D” Appears when a duplex channel is selected.

⑦ WEATHER CHANNEL INDICATOR (p. 6)

➤ “WX” appears when a weather channel is selected.

➤ “ALT” appears when the weather alert function is in use; flashes when an alert tone is received.

⑧ GPS INDICATOR

➤ “GPS” appears while valid position data is received.

➤ “GPS” blinks when invalid position data is received.

➤ “GPS” disappears when no GPS receiver is connected.

⑨ DSC INDICATOR

➤ Indicates the DSC status.

⑩ CHANNEL NAME INDICATOR

➤ Channel comment appears if programmed. (p. 7).

➤ “LOW BATTERY” scrolls when the battery voltage drops to approx. 10 V DC or below.

➤ “DW” appears during dualwatch; “TW” appears during tri-watch. (p. 8)

⑪ CHANNEL NUMBER READOUT

➤ Indicates the selected operating channel number. “A” appears when a simplex channel is selected. (p. 5)

➤ In set mode, indicates the selected condition. (p. 20)

⑫ CHANNEL NUMBER READOUT

Indicates whether a U.S.A. (USA), International (INT), or Canadian (CANADA) channel is in use.

■ Microphone

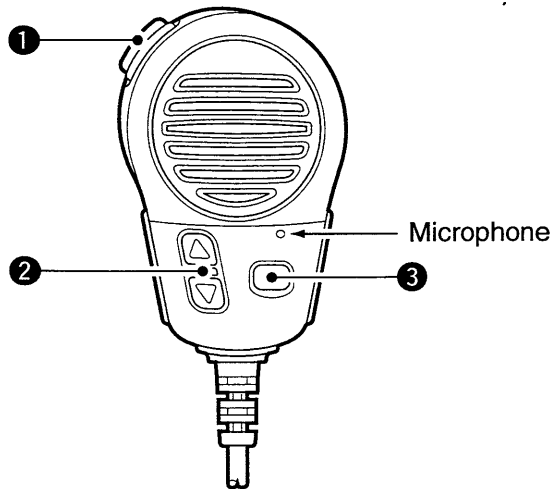

① PTT SWITCH [PTT]

Push and hold to transmit; release to receive. (p. 6)

② CHANNEL UP/DOWN SWITCHES [▲]/[▼]

Push either switch to change the operating channel, set mode contents, etc. (p. 6)

③ CHANNEL 16/CALL CHANNEL SWITCH [16/9]

➔ Same function as the [16•9] switch on the front panel. (p. 2)

- Selects Ch 16 when pushed. (p. 5)
- Selects call channel when pushed for 1 sec. (p. 5)
 - “CALL” appears when call channel is selected.
- Push for 3 sec. to enter call channel programming mode when call channel is selected. (p. 7)

- While push and hold [H/L] on the front panel push [16/9] to enter memory channel name programming condition. (p. 7)
- While push and hold [16/9] on the supplied microphone, turn power ON to toggle the microphone lock function ON and OFF. (p. 6)

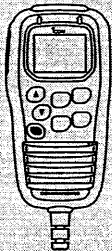

NOTE:

The optional **HM-127** REMOTE CONTROL MICROPHONE and **OPC-999** MICROPHONE EXTENSION CABLE can be connected to **IC-M402 only.**

- ➔ p. 19 Intercom operation
- ➔ p. 26-37 HM-127 REMOTE-CONTROL MICROPHONE)

IC-M402S has **no external microphone speaker jack** for connecting **HM-127** and **OPC-999.**

Channel selection

◆ Channel 16

Ch 16 is the distress and safety channel. It is used for establishing initial contact with another station and for emergency communications. Channel 16 is monitored during both dual-watch and tri-watch. While standing by, you must monitor Ch 16.

➔ Push [16] momentarily to select Ch 16.

➔ Push [CH/WX] to return to the condition before selecting Ch 16, or push [▲]/[▼] to select an operating channel.

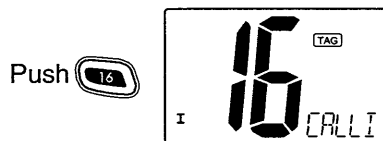

◆ Channel 9 (Call channel)

Each regular channel group has a separate leisure-use call channel. The call channel is monitored during tri-watch. The call channels can be programmed (p. 7) and are used to store your most often used channels in each channel group for quick recall.

➔ Push [16] for 1 sec. to select the call channel of the selected channel group.

- "CALLING" and call channel number appear.
- Each channel group may have an independent call channel.

➔ Push [CH/WX] to return to the condition before selecting call channel, or push [▲]/[▼] to select an operating channel.

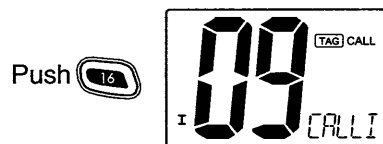

◆ U.S.A., Canadian and international channels

There are 57 U.S.A., 61 Canadian and 57 international channels. These channel groups may be specified for the operating area.

- ① Push [CH/WX] to select a regular channel.
 - If a weather channel appears, push [CH/WX] again.
- ② Push [CH/WX] while pushing [H/L] to change the channel group, if necessary.
 - U.S.A., International (INT) and Canadian channels can be selected in sequence.
- ③ Push [▲]/[▼] to select a channel.
 - "D" appears for duplex channels.
 - "A" appears for simplex channels.

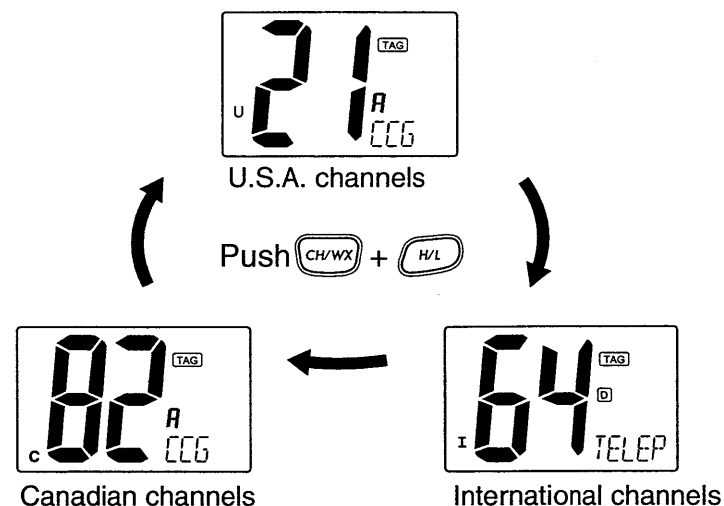

◆ Weather channels

There are 10 weather channels. Used for monitoring weather channels from the NOAA (National Oceanographic and Atmospheric Administration) broadcasts.

The transceiver can detect a weather alert tone on the selected weather channel while receiving the channel, during standby on a regular channel or while scanning. (p. 20)

- ① Push [CH/WX] once or twice to select a weather channel.
 - “WX” appears when a weather channel is selected. “WX ALT” appears when the weather alert function is in use. (p. 20)
- ② Push [▲]/[▼] to select a channel.
 - Channels are memorized separately for each channel group.

Push

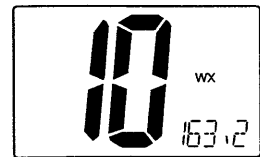
 once
 or
 twice

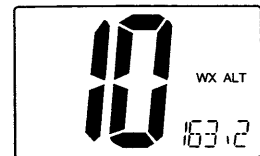

When weather alert is OFF.



When weather alert is ON.

■ Microphone lock function

The microphone lock function electrically locks the [▲]/[▼] and [16/9] switches on the supplied microphone. This prevents accidental channel changes and accidental function access.

- ➔ While pushing [16/9] on the supplied microphone, turn power ON to toggle the lock function ON and OFF.

■ Receiving and transmitting

CAUTION: Transmitting without an antenna may damage the transceiver.

- ① Turn [VOL] right to turn power ON.
- ② Set the audio and squelch levels.
 - ➔ Rotate [SQL] fully counterclockwise in advance.
 - ➔ Rotate [VOL] to adjust the audio output level.
 - ➔ Rotate [SQL] clockwise until the noise disappears.
- ③ Push [▲]/[▼] to select the desired channel. (p. 5)
 - When receiving a signal, “BUSY” appears and audio is emitted from the speaker.
- ④ Push [H/L] to select the output power if necessary.
 - “LOW” appears when low power is selected.
 - Choose high power for stronger signal propagation.
 - Some channels are for low power only.
- ⑤ Push and hold [PTT] to transmit, then speak into the microphone.
 - “TX” appears.
 - Channel 70 cannot be used for transmission (for DSC use).

Simplex channels, 3, 21, 23, 61, 64, 81, 82 and 83 CANNOT be lawfully used by the general public in U.S.A. waters.

- ⑥ Release [PTT] to receive.

IMPORTANT: To maximize the readability of your transmitted signal, pause a few sec. after pushing [PTT], hold the microphone 1 to 2 inches (2.5 to 5 cm) from your mouth and speak at a normal voice level.

3 BASIC OPERATION

■ Call channel programming

The call channel is used to select Ch 9, however, you can program your most often-used channels in each channel group for quick recall.

- ① While pushing [H/L], push [CH/WX] one or more times to select the desired channel group (U.S.A., International, Canada) to be programmed.
 - “CALL” and call channel number appear.
- ② Push [16] for 1 sec. to select the call channel of the selected channel group.
 - “CALL” and call channel number appear.
- ③ Push [16] again for 3 sec. (until long beep changes to 2 short beeps) to enter call channel programming mode.
 - Channel number starts flashing.
- ④ Push [▲]/[▼] to select the desired channel.
- ⑤ Push [16] to program the displayed channel as the call channel.
 - Push [CH/WX] to cancel.
 - The channel number stops flashing.

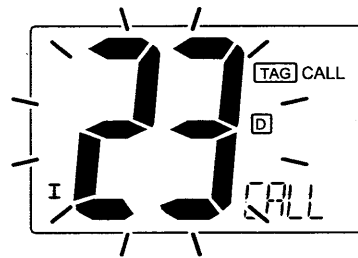
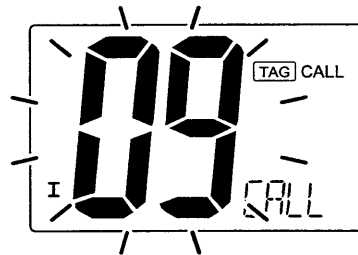

■ Channel names

Memory channels can be tagged with alphanumeric names of up to 10 characters each.

Capital letters, small letters, numerals, some symbols (! " # \$ % & ' () * + , - . /) and spaces can be used.

- ① Select the desired memory channel.
 - Cancel dualwatch, tri-watch or scan in advance.
- ② While pushing [H/L], push [16] to edit memory channel name.
 - A cursor appears and blinks.

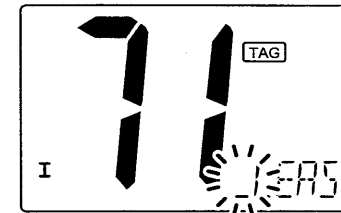

- ③ Select the desired character by pushing [▲]/[▼].
 - Push [CH/WX] or [H/L] for cursor movement.
- ④ Push [16] to input and set the name.
 - Push [H/L] to cancel.
 - The cursor disappears.
- ⑤ Repeat steps ① to ④ to program other memory channel names, if desired.

■ Description

Dualwatch monitors Ch 16 while you are receiving an-other channel; tri-watch monitors Ch 16 and the call channel while receiving another channel.

DUALWATCH/TRI-WATCH SIMULATION

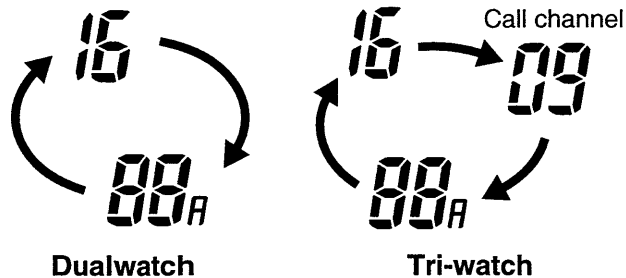

- If a signal is received on Channel 16, dualwatch/tri-watch pauses on Ch 16 until the signal disappears.
- If a signal is received on the call channel during tri-watch, tri-watch becomes dualwatch until the signal disappears.
- To transmit on the selected channel during dualwatch/tri-watch, push and hold [PTT].

■ Operation

- ① Select the desired operating channel.
- ② Select dualwatch or tri-watch in set mode. (p. 20)
- ③ Push [CH/WX] for 1 sec. to start dualwatch or tri-watch.
 - “DW” appears during dualwatch; “TW” appears during tri-watch.
 - Beep tone sounds when a signal is received on Channel 16.
- ④ To cancel dualwatch/tri-watch, push [CH/WX] again.

[Example]:

Operating dualwatch on INT Ch 25



Dual-watch starts.

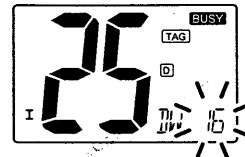

Signal received on channel 16 takes priority.

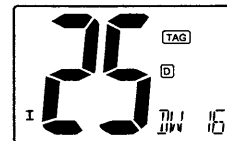

Dual-watch resumes after the signal disappears.

Operating tri-watch on INT Ch 25

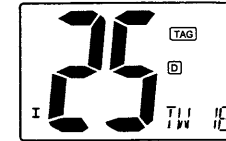

Tri-watch starts.

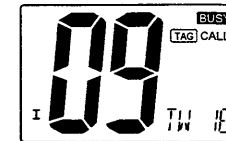

Signal is received on call channel.

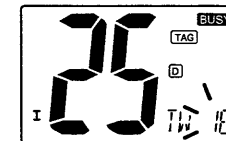

Signal received on channel 16 takes priority.

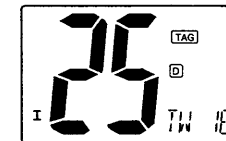

Tri-watch resumes after the signal disappears.

■ Setting tag channels

For more efficient scanning, add desired channels as tag channels or clear tag channels for unwanted channels. Channels set as non-tag channels will be skipped during scanning. Tag channels can be assigned to each channel group (U.S.A., International, Canada) independently.

- ① While pushing [H/L], push [CH/WX] one or more times to select the desired channel group, if desired.
- ② Select the desired channel to set as a tag channel.
- ③ Push [▲] and [▼] simultaneously for 1 sec. to set the displayed channel as a tag channel.
 - “TAG” appears in the function display.
- ④ To cancel the tag channel setting, repeat ③.
 - “TAG” disappears.

•Clearing all tag channels in the selected channel group

- ➔ While pushing [▲] and [▼], Turn power ON to clear all tag channels in the channel group.

■ Starting a scan

Set scan type (priority or normal scan) and scan resume timer in advance using set mode. (p. 20)

- ① Set tag channels as described at left.
- ② Make sure the squelch is closed to start a scan.
- ③ While pushing [H/L], push [CH/WX] one or more times to select the desired channel group, if desired.
- ④ Push [▲] or [▼] for 1 sec. to start priority or normal scan.
 - “Pri scan 16” or “Normal scan” appears in the function display.
 - When a signal is detected, scan pauses until the signal disappears or resumes after pausing 5 sec. according to set mode setting. (Channel 16 is still monitored during priority scan.)
 - While in the scanning, use [▲] and [▼] key to check tag channels, change the scanning direction or resume the scan manually.
 - “16” flashes and a beep tone sounds when a signal is received on Channel 16 during priority scan.
 - Push [▲] and [▼] for 1 sec. to set the paused channel as a tag channel.
- ⑤ To stop the scan, push [▲] or [▼].

[Example]: Starting a priority scan.

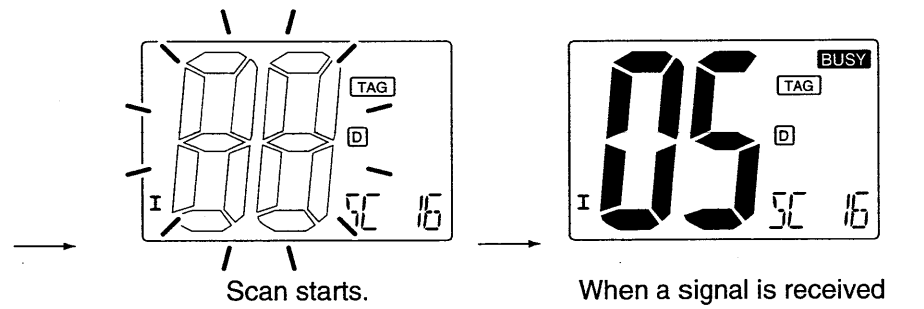
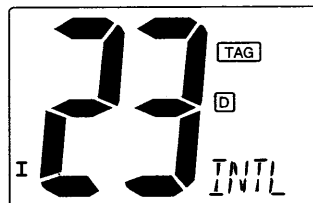

■ Scan types

Scanning is an efficient way to locate signals quickly over a wide frequency range. The transceiver has priority scan and normal scan.

When the weather alert function is in use, the selected weather channel is checked while scanning. (p. 20)

Set the tag channels (scanned channel) before scanning. Clear the tag channels which inconveniently stop scanning, such as digital communication use.

/// Choose priority or normal scan in set mode. (p. 20)

PRIORITY SCAN

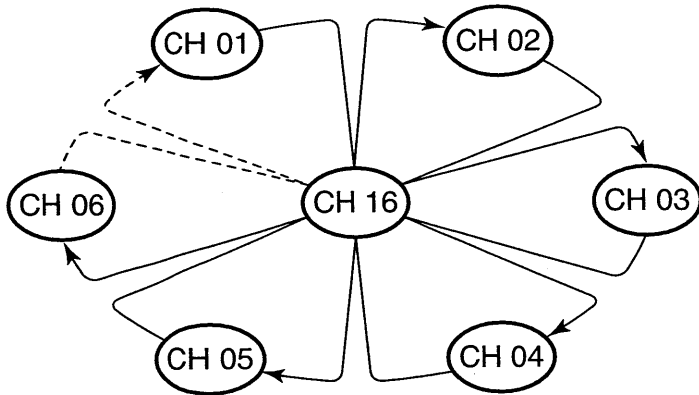

Priority scan searches through all tag channels in sequence while monitoring Ch 16. When a signal is detected on Ch 16, scan pauses until the signal disappears; when a signal is detected on a channel other than Ch 16, scan becomes dualwatch until the signal disappears.

NORMAL SCAN

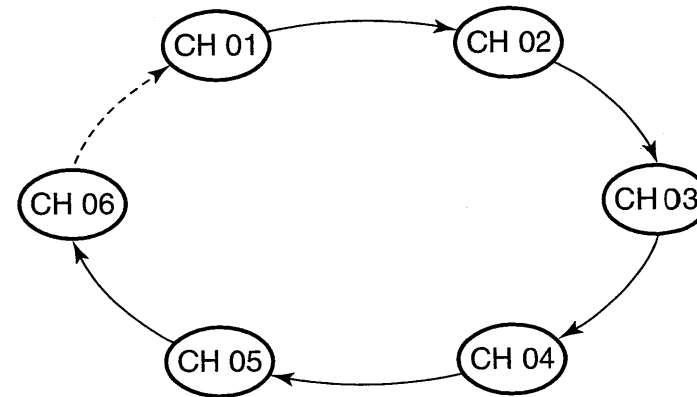

Normal scan, like priority scan, searches through all tag channels in sequence. However, unlike priority scan, Ch 16 is not checked unless Ch 16 is set as a tag channel.

■ MMSI code programming

The 9-digit MMSI (DSC self ID) code can be programmed at power ON.

/// This function is not available when the MMSI code has been programmed by the dealer. This code programming can be performed only 2 times.

- ① Turn power OFF.
- ② While pushing [DSC], turn power ON to enter MMSI code programming condition.
- ③ After the display appears, release [DSC].
- ④ Select the desired number by pushing [▲]/[▼].
- ⑤ Push [H/L] to advance the cursor.
 - Push [CH/WX] to move the cursor backward.
- ⑥ Repeat steps ④ and ⑤ to input 9 digit code.
- ⑦ Push [DSC] to input and set the code.
 - The previously selected channel appears.

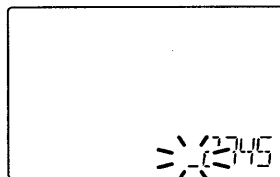

■ MMSI code check

The 9-digit MMSI (DSC self ID) code can be checked.

- ① Push [DSC] to select the DSC menu.
- ② Push [▲]/[▼] to select "MMSI" and push [DSC].

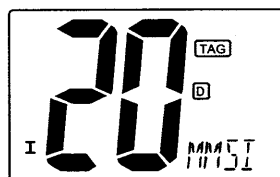

- ③ Check the 9-digit MMSI (DSC self ID) code.
- ④ Push [DSC] to exit the condition.

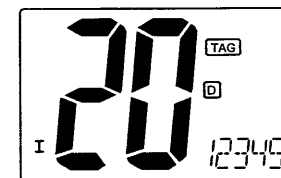

■ Position indication

When a GPS receiver (NMEA0183 ver. 2.0) is connected, the transceiver can display the current position and time.

- ➔ While pushing [H/L], push [DSC] for 1 sec. to display the current position.
 - "Latitude and longitude are displayed alternately."

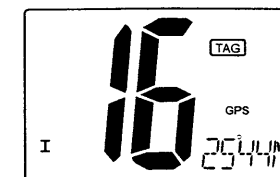
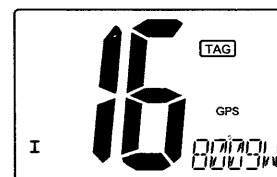

■ Distress call

A distress call should be transmitted if, in the opinion of the Master, the ship or a person is in distress and requires immediate assistance.

- All keys, switches and controllers on the transceiver are functional.

NEVER USE THE DISTRESS CALL WHEN YOUR SHIP IS NOT IN AN EMERGENCY. A DISTRESS CALL CAN BE USED ONLY WHEN IMMEDIATE HELP IS NEEDED.

① Confirm that a distress call is not being received.

② While lifting up the switch cover, push the [DISTRESS] switch for 5 sec. to transmit the distress call.

- An emergency channel (Ch 70) is automatically selected and the distress call is transmitted.

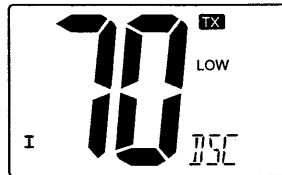

③ After transmitting the call, the transceiver waits for an acknowledgment call on Ch70.

- The distress call is automatically transmitted every 3.5 to 4.5
- "DSC RPEAT" scrolls.

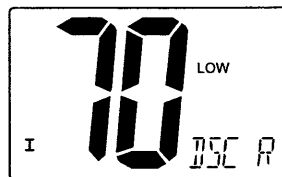

④ When receiving the acknowledgment, reply to the connected station via the microphone.

- "RCV Distress ACK" scrolls.

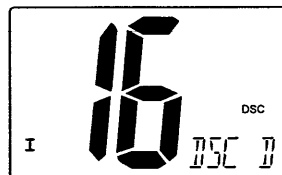

➔ Distress alert contains (default);

- Kinds of distress : Undesignated distress
- Position data : Latest GPS position data held for 23.5 hrs. or until the power is turned OFF.

➔ The distress call is repeated every 3.5–4.5 min., until receiving an 'acknowledgement.'

➔ Push [DISTRESS] to transmit a renewed distress call, if desired.

➔ Push [16] to cancel the 'Call repeat' mode.

6 DSC OPERATION

■ Transmitting DSC calls

◆ Transmitting individual call

The individual call function allows you to transmit a DSC signal to a specific party only.

- ① Select a desired channel other than Ch 70.
- ② Push [DSC] to select the DSC menu.
- ③ Push [▲]/[▼] to select "individual" and push [DSC].
- ④ Push [▲]/[▼] to select the desired pre-programmed individual address.
 - The ID code for the individual call can be set in advance. (p. 16)
- ⑤ Push [DSC] to enter pre-programmed individual address.
 - "OK" appears.
- ⑥ Push [DSC] to transmit the individual call.
 - Ch1 70 is selected and the individual call is transmitted to the selected station.
 - If Ch 70 is busy, the transceiver stands by until the channel becomes clear.
 - Routine category only is available.

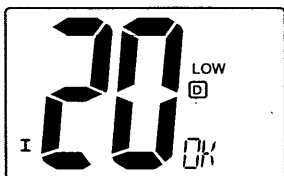
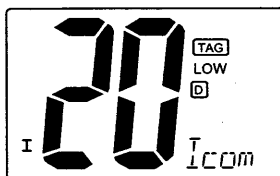
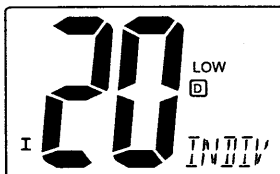

Push [DSC] to transmit DSC call.

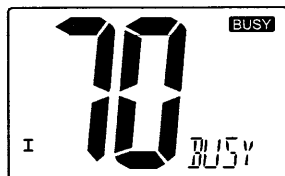

When Ch 70 is busy.

- ⑦ Standby on Ch 70 until an acknowledgement is received.

- "WAITING ACK" scrolls.

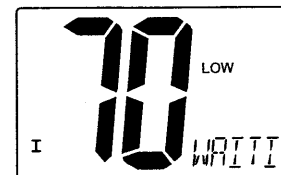

- ⑧ When the acknowledgement is received, the display changes to the previously selected user channel with beeps.
- ⑨ Push and hold [PTT] to communicate your message to the responding party.

◆ Transmitting individual acknowledgement

Transmit an acknowledgement ('able to comply' or 'unable to comply') when an individual call for you is received.

- ① "RCV Individual" scrolls.
- ② Push [▲] or [▼] to select the acknowledgement "ABLE" or "UNABLE".

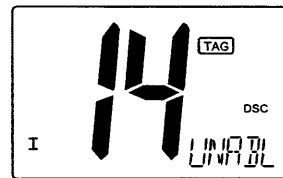
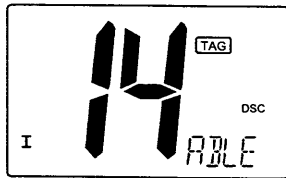

- ③ Push [DSC] to enter selected individual call acknowledgement, "OK" appears.

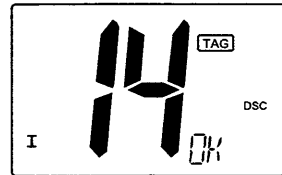

- ④ Push [DSC] to transmit individual call acknowledgement.



- ⑤ If you select "Able", the channel specified by the calling station is automatically selected.

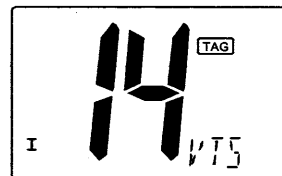

◆ Transmitting all ships call

Large ships use Ch 70 as their "listening channel."

When you want to announce a message to these ships, use the "all ships call" function.

- ① Select a desired channel other than Ch 70.
- ② Push [DSC] to select the DSC menu.
- ③ Push [▲]/[▼] to select "ALL SHIPS".
•Routine category only is available.

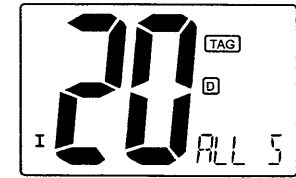

- ④ Push [DSC] to enter all ships call.
•"OK" appears.

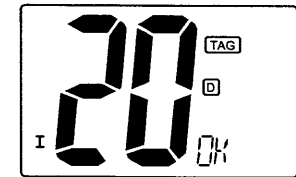

- ⑤ Push [DSC] to transmit the all ships call.
•Ch 70 is selected and the all ships call is transmitted.
•Routine category only is available.

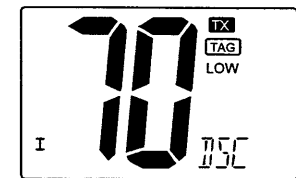

- ⑥ The all ships call has been transmitted.
•A previous channel is selected automatically.



- ⑦ Push [PTT] or [▲]/[▼] to exit the condition.

6 DSC OPERATION

◇ Transmitting position request call

Transmit a position request call when you want to know your friend's current position, etc.

- ① Select a desired channel other than Ch 70.
- ② Push [DSC] to select the DSC menu.
- ③ Push [▲]/[▼] to select "POS RE-QUEST."

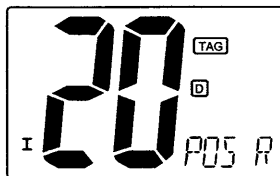

- ④ Push [▲]/[▼] to select the desired pre-programmed individual address.
 - The ID code for position request can be set in advance. (p. 16)

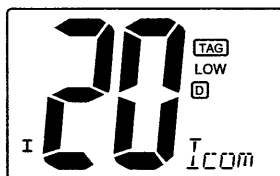

- ⑤ Push [DSC] to enter pre-programmed individual address.
 - "OK" appears.
- ⑥ Push [DSC] to transmit the position request call.
 - Ch 70 is selected and the position request call is transmitted.



- ⑦ The position request call has been transmitted.
 - "WAITING ACK" scrolls.

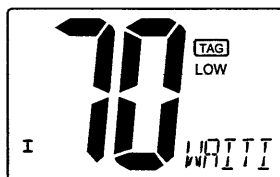

- ⑧ Push [PTT] or push [▲]/[▼] to exit the condition.

◇ Transmitting position reply call

Transmit a position reply call when a position request call is received.

- ① "DSC" appears and a "RCV Pos request" scrolls in the display.

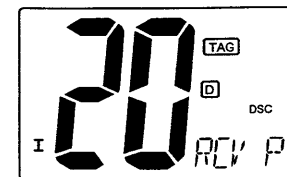

- ② Push [DSC] to reply to the position request call; push [H/L] to ignore the position request call.

■ DSC individual ID

A total of 30 DSC address ID's can be programmed and named with up to 10 characters.

◆ Programming address ID

- ① Push [DSC] to select the DSC menu.
- ② Push [▲]/[▼] to select "ADDRESS" and push [DSC].



- ③ Push [▲]/[▼] to select "ADD" and push [DSC].

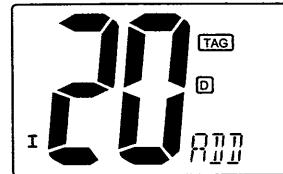

- ④ Set the distress ID and ID name, then push [DSC].

- Push [▲]/[▼] to select the character.
- Push [H/L] to advance the cursor.
- Push [CH/WX] to move the cursor backward.
- Push [16] to cancel and exit the condition.
- Up to 5 characters available to enter ID names.

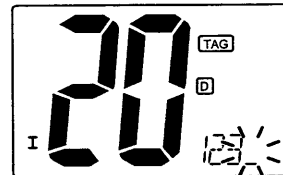

- ⑤ Push [DSC] to program and to exit the ID programming mode.

◆ Deleting address ID

- ① Push [DSC] to select the DSC menu.
- ② Push [▲]/[▼] to select "ADDRESS" and push [DSC].
- ③ Push [▲]/[▼] to select 'DEL,' then push [DSC].
 - When no address ID is programmed, the transceiver exits the condition automatically.
- ④ Select the desired ID name pushing [▲]/[▼], then push [DSC].
- ⑤ Push [DSC] to delete the address ID; push an other switch to exit the condition.

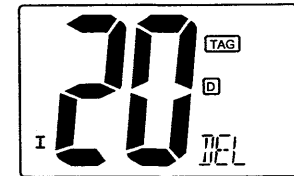

6 DSC OPERATION

■ Receiving DSC calls

◆ Receiving a distress call

While monitoring Ch 70 and a distress call is received:

- ➔ Emergency alarm sounds for 2 minutes.
 - Push any switch to stop the alarm.
- ➔ “DSC” appears and “RCV Distress” scrolls in the display, then Ch 16 is automatically selected.
- ➔ Continue monitoring Channel 16 as a coast station may require assistance.

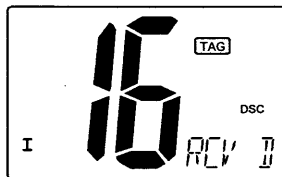

◆ Receiving a distress acknowledgement

While monitoring Ch 70 and a distress acknowledgement to other ship is received:

- ➔ Emergency alarm sounds for 2 minutes.
 - Push any switch to stop the alarm.
- ➔ “RCV Distress ACK” scrolls in the display, then Channel 16 is automatically selected.

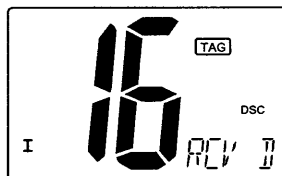

◆ Receiving a distress relay acknowledgement

While monitoring Ch 70 and a distress relay acknowledgement is received:

- ➔ Emergency alarm sounds for 2 minutes.
 - Push any switch to stop the alarm.

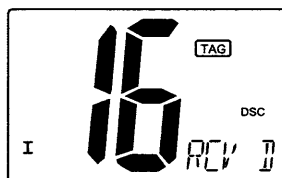

- ➔ “RCV Distress Relay ACK” scrolls in the display; then Ch 16 is automatically selected.

◆ Receiving a distress relay call

While monitoring Ch 70 and a distress relay call is received:

- ➔ Emergency alarm sounds for 2 minutes.
 - Push any switch to stop the alarm.
- ➔ “RCV Distress Relay” appears in the display, then Channel 16 is automatically selected.
- ➔ Monitor Channel 16 until the emergency communication has been completed.

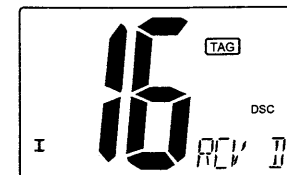

◆ Receiving an all ships call

While monitoring Ch 70 and an all ships call is received:

- ➔ Emergency alarm sounds when the category is “Distress” or “Urgency;” 2 beeps sound for other categories.
- ➔ “RCV All ships” scrolls in the display; then, the channel specified by the calling station is automatically selected for voice communication.
- ➔ Monitor the selected channel for an announcement from the calling vessel.

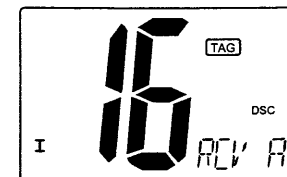

◆ **Receiving an individual call**

While monitoring Ch 70 and an individual call is received:

- ➔ Emergency alarm or beeps sound depending on the received category.
- ➔ “RCV Individual” scrolls in the display, then the channel specified by the calling station is automatically selected for checking the channel condition.

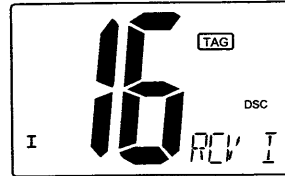

◆ **Receiving a geographical area call**

While monitoring Ch 70 and a geographical area call (for the area you are in) is received:

- ➔ Emergency alarm or beeps sound depending on the received category.
- ➔ “RCV Geographic” scrolls, then the channel specified by the calling station is automatically selected for voice communications.
- ➔ Monitor the selected channel for an announcement from the calling ship.

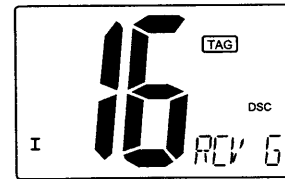

When no GPS receiver is connected or if there is a problem with the connected receiver, all geographical area calls are received, regardless of your position.

◆ **Receiving a position reply call**

While monitoring Ch 70 and a position reply call (for the area you are in) is received:

- ➔ “Received POS” appears in the display.
- “Latitude and longitude are displayed alternately.

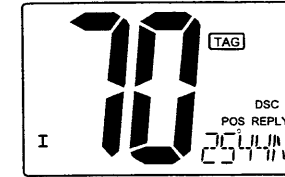
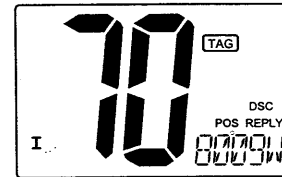

When no GPS receiver is connected or if there is a problem with the connected receiver, all geographical area calls are received, regardless of your position.

◆ **Receiving a position request call**

While monitoring Ch 70 and a position request call (for the area you are in) is received:

- ➔ “RCV Pos request” scrolls in the display.
- ➔ Push [DSC] to reply to the call.

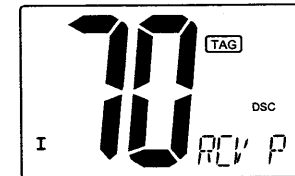

When no GPS receiver is connected or if there is a problem with the connected receiver, all geographical area calls are received, regardless of your position.

Intercom operation

The optional intercom function allows you to talk to the deck from the cabin. The **optional HM-127 REMOTE-CONTROL MICROPHONE is required** for intercom operation.

Connect an optional HM-127 as described on p. 36.

- Transmitting is impossible during intercom operation.
- The received signal is muted during intercom operation.

① Push [DSC] for 1 sec. to enter intercom mode.

- The HM-127 power is automatically turned ON, even if the HM-127 power is OFF.

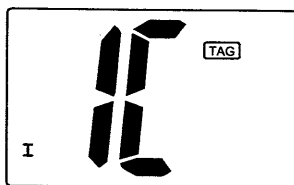

IC-M402

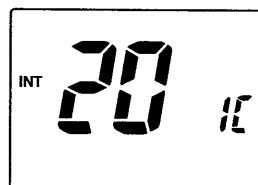

HM-127

② Push and hold [DSC] again to call up.

- The transceiver and microphone emit call beeps.

③ Push and hold the PTT switch and speak at a normal voice level into the microphone.

- "TALK" or "LSTN" appears on the caller or listener function display, respectively.
- To adjust the IC-M402's speaker output level, rotate [VOL].
- To adjust the HM-127's speaker output level, push [▲]/[▼] after pushing [VOL] on the HM-127.

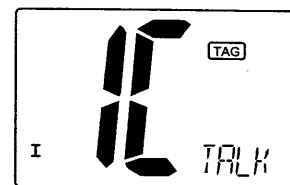

IC-M402 (caller)

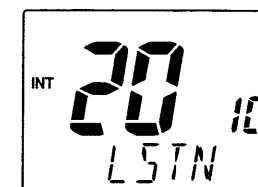

HM-127 (listener)

④ After releasing the PTT switch you can hear the response through the speaker.

⑤ To return to normal operation, push [DSC] momentarily.

- Other switches also turn the function OFF, however, the corresponding function is then activated e.g. pushing [16] selects Ch 16.

• While in the intercom mode, the transceiver functions (transmit and receive) are interrupted. If the transceiver is in transmit condition, the intercom function is not available.

• When a DSC call is received, "DSC received" appears and the last received DSC message is displayed after the intercom use is finished.

• When a WX alert is received, "WX ALT" flashes and a beep sounds. The WX alert sounds after the intercom use is finished.

■ Set mode programming

Set mode is used to change the conditions of some of the transceiver's functions.

- Available functions may differ depending on dealer setting.
- The optional HM-127 has it's own settings for the beep tone and LCD contrast. (p. 34)

- ① Turn power OFF.
- ② While pushing and holding [16], turn power ON to enter set mode.
- ③ After the display appears, release [16].
- ④ Push [16] to select the desired item, if necessary.
- ⑤ Push [▲]/[▼] to select the desired condition of the item.
- ⑥ Turn power OFF, then ON again to exit set mode.

• SET MODE CONSTRUCTION

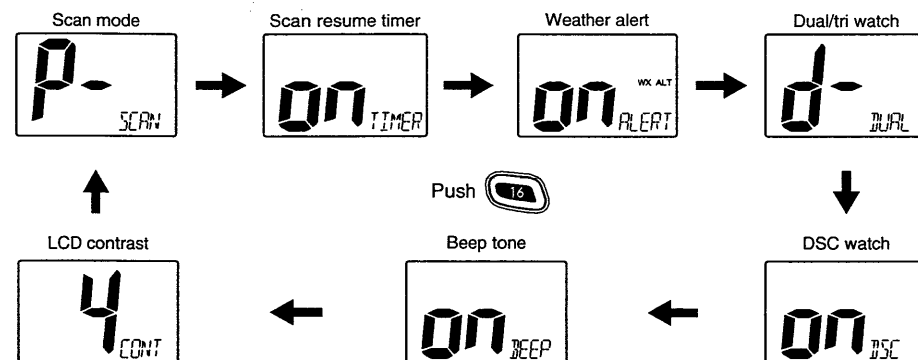

■ Set mode items

◆ Scan mode

The scan mode can be selected as a normal scan or priority scan. (p. 9)



Normal scan (default)

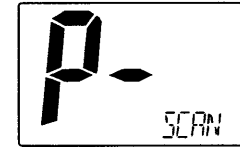

Priority scan

◆ Scan resume timer

The scan resume timer can be selected as a pause (OFF) or timer scan (ON). When OFF is selected, the scan pauses



Scan timer OFF (default)



Scan timer ON

until the signal disappears. When ON is selected, the scan pauses 5 sec. and resumes even if a signal is being received on channels except for Channel 16.

◆ Weather alert

An NOAA broadcast station transmits a weather alert tone before important weather information. When



Weather alert OFF (default)

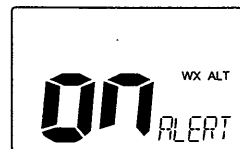

Weather alert ON

the weather alert function is turned ON, the transceiver detects the alert, then flashes the "WX ALT" indicator until the transceiver is operated. The previously selected (used) weather channel is checked any time during standby or while scanning.

- "ALT" appears with "WX" indication when the function is set ON.

8 SET MODE

◆Dual/tri watch

This item can be selected as dualwatch or tri-watch. (p. 8)



Dual watch (default)

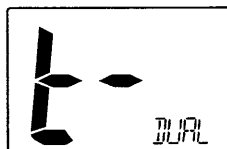

Tri-watch

◆DSC watch

DSC watch monitors Ch 70 while you are receiving another channel.



DSC watch ON (default)

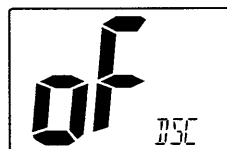

DSC watch OFF

If a distress signal is received on Ch 70, the transceiver monitors Ch 16 and Ch 70 alternately until the distress signal disappears. If a signal is received on another channel, DSC watch pauses until the signal disappears.

/// This function may not be available for some channel groups depending on dealer setting.

◆Beep tone

You can select silent operation by turning beep tones OFF or you can have confirmation beeps sound at the push of a switch by turning beep tones ON.

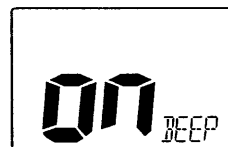

Beep tone ON (default)



Beep tone OFF

◆LCD contrast

This item adjusts the contrast of the LCD in 4 steps.



LCD contrast 3 (default)

■ Supplied accessories

The following accessories are supplied:

| | Qty. |
|---------------------------------------|------|
| ① Mounting bracket | 1 |
| ② DC power cable (OPC-891) | 1 |
| ③ Microphone hanger | 1 |
| ④ Mounting bracket knobs | 2 |
| ⑤ Mounting screws (5 × 20 mm) | 2 |
| ⑥ Mic hanger screws (3 × 16 mm) | 2 |
| ⑦ Flat washers (M5) | 2 |
| ⑧ Spring washers (M5) | 2 |
| ⑨ WARNING STICKER | 1 |

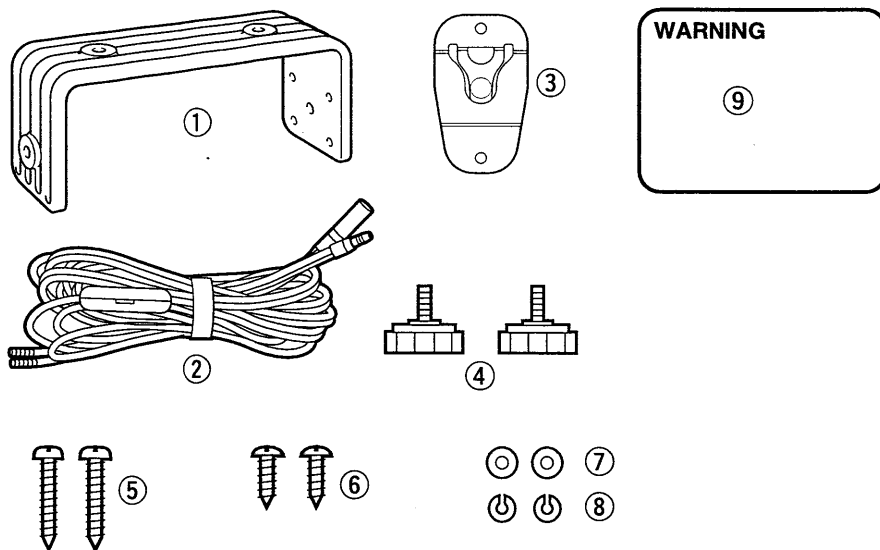

■ Warning sticker attachment

A **WARNING STICKER** is supplied with the transceiver. To comply with FCC regulations, this sticker must be affixed in such a location as to be readily seen from the operating controls of the radio. Make sure the chosen location is clean and dry before applying the sticker.

■ Antenna

A key element in the performance of any communication system is an antenna. Ask your dealer about antennas and the best places to mount them.

■ Fuse replacement

One fuse is installed in the supplied DC power cable. If a fuse blows or the transceiver stops functioning, track down the source of the problem, if possible, and replace the damaged fuse with a new, rated one.

■ Cleaning

If the transceiver becomes dusty or dirty, wipe it clean with a soft, dry cloth.

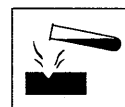

AVOID the use of solvents such as benzene or alcohol, as they may damage transceiver surfaces.

9 INSTALLATION AND MAINTENANCE

■ Connections

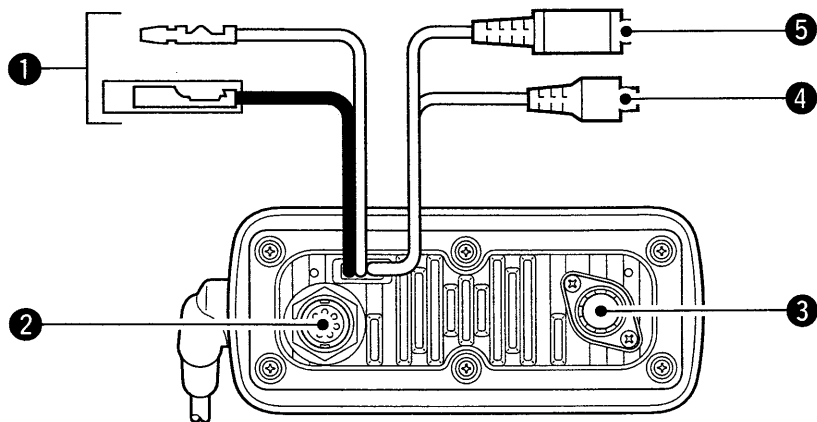

❶ DC POWER CONNECTOR

Connects the supplied DC power cable from this connector to an external 12 V battery.

❷ EXTERNAL MICROPHONE JACK (IC-M402 only)

Connects to optional HM-127 REMOTE-CONTROL MICROPHONE.

❸ ANTENNA CONNECTOR

Connects a marine VHF antenna with a PL-259 connector to the transceiver.

CAUTION: Transmitting without an antenna may damage the transceiver.

❹ GPS RECEIVER JACK

Connects to a GPS receiver to input the position data and time data.

- A GPS receiver requires an NMEA0183 ver. 2.0 for position or time indication, etc. Ask your dealer about the GPS receiver.

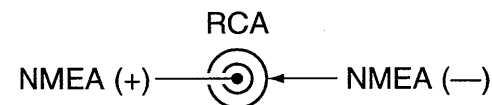

❺ EXTERNAL SPEAKER JACK

Connects to an external speaker. See 'Options' on p. 29 for available external speakers.

• MICROPHONE HANGER

Rest the supplied microphone on the hanger when not in use.

CAUTION: After connecting the DC power cable, GPS receiver jack and external speaker jack, cover the connector and jacks with an adhesion tape as shown below, to prevent water seeping into the transceiver.

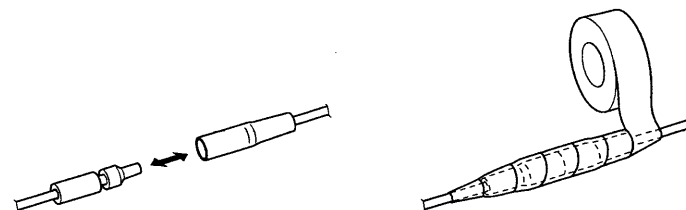

■ Mounting the transceiver

◆ Using the supplied mounting bracket

The universal mounting bracket supplied with your transceiver allows overhead or dashboard mounting.

- Mount the transceiver securely with the 2 supplied screws (M5 x 20) to a surface which is more than 10 mm thick and can support more than 5 kg.
- Mount the transceiver so that the face of the transceiver is at 90° to your line of sight when operating it.

/// **CAUTION: KEEP** the transceiver and microphone at least 1 meter away from your vessel's magnetic navigation compass.

/// **NOTE:** Check the installation angle; the function display may not be easy-to-read at some angles.

EXAMPLE

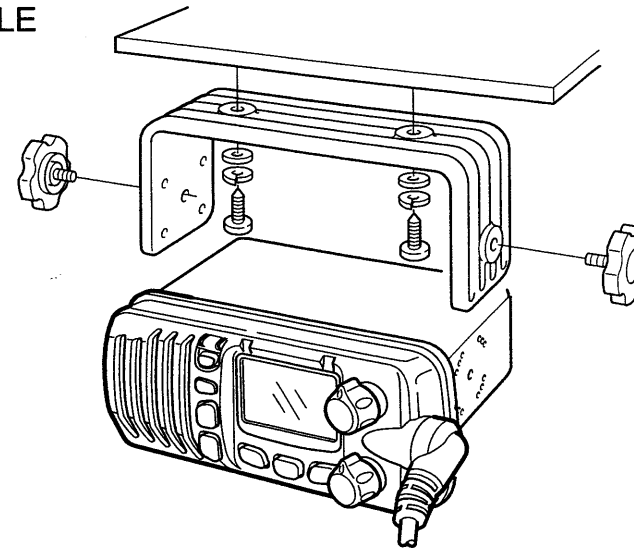

9 INSTALLATION AND MAINTENANCE

■ MB-69 mounting bracket (option)

An optional MB-69 FLUSH MOUNT is available for mounting the transceiver to a flat surface such as an instrument panel.

CAUTION: KEEP the transceiver and microphone at least 1 meter away from your vessel's magnetic navigation compass.

- ① Using the template on the last page, carefully cut a hole into the instrument panel (or wherever you plan to mount the transceiver).
- ② Slide the transceiver through the hole as shown below.

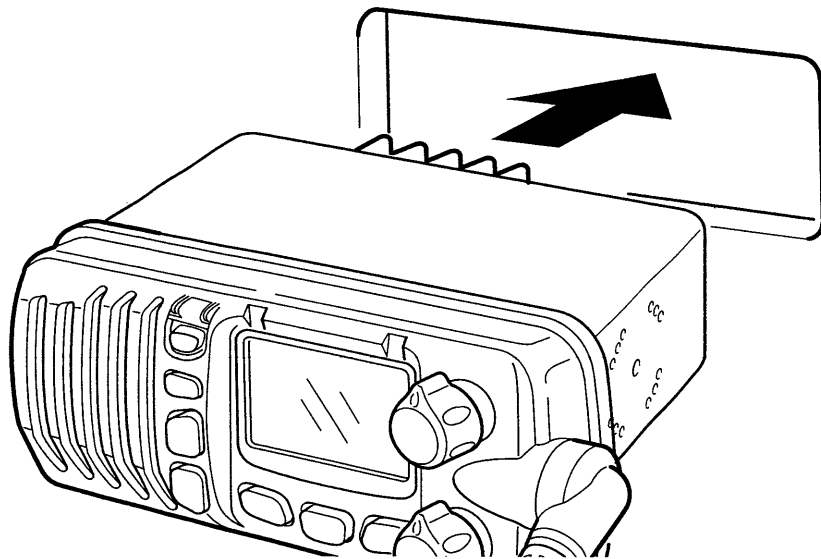

- ③ Attach the clamps on either side of the transceiver with 2 supplied bolts (5 × 8 mm).
 - Make sure that the clamps align parallel to the transceiver body.

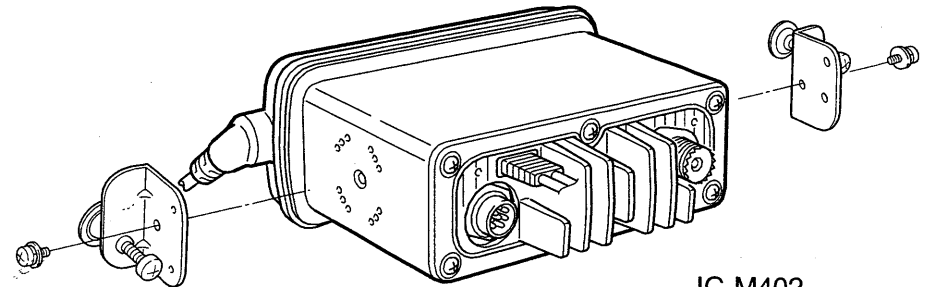

- ④ Tighten the end bolts on the clamps (rotate clockwise) so that the clamps press firmly against the inside of the instrument control panel.
- ⑤ Tighten the locking nuts (rotate counterclockwise) so that the transceiver is securely mounted in position as below.
- ⑥ Connect the antenna and control cable, then return the instrument control panel to its original place.

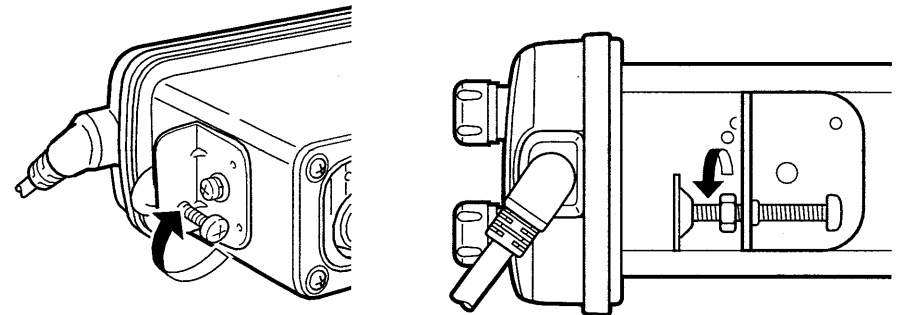

■ Panel description

The optional HM-127 remotely controls the IC-M402 and provides an optional intercom function.

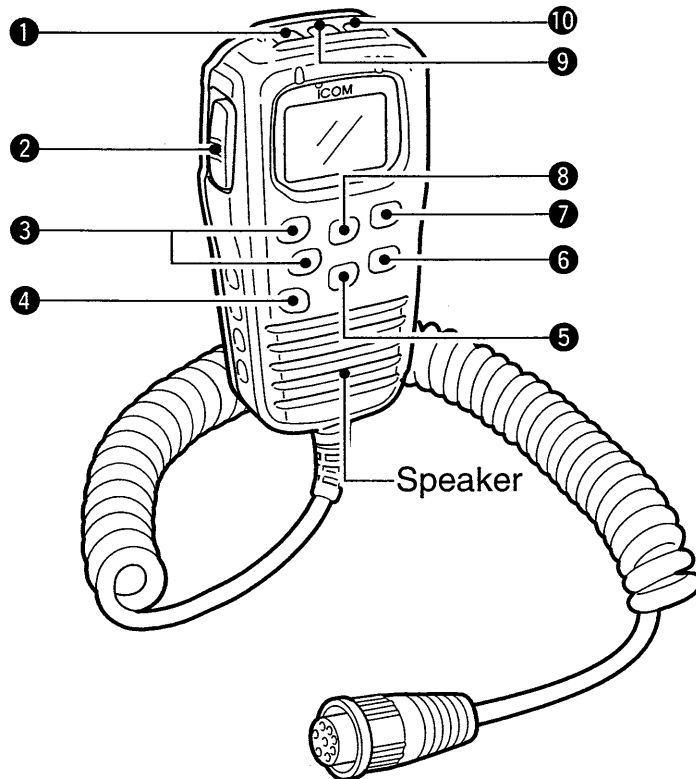

❶ POWER SWITCH [PWR] (p. 29)

Push for 2 sec. to turn the HM-127 power ON or OFF when the IC-M402 power is turned ON.

❷ PTT SWITCH [PTT] (pgs. 6, 29)

Push and hold to transmit; release to receive.

❸ CHANNEL UP/DOWN SWITCHES [▲]/[▼]

- Push either switch to change the operating channel, set mode contents, etc. (pgs. 6, 29)
- While pushing [H/L], push [▲]/[▼] to adjust the brightness of the LCD and switch backlight. (p. 32)
- Push either switch to adjust audio level or noise squelch level after [VOL] or [SQL] is pushed, respectively. (pgs. 20, 29)
- In set mode, changes setting of the selected item. (pgs. 20, 34)
- Checks tag channels or changes scanning direction during scan. (pgs. 9, 33)

❹ CHANNEL 16/CALL CHANNEL SWITCH [16•9]

- Selects Ch 16 when pushed. (pgs. 5, 31)
- Selects call channel when pushed for 1 sec. (pgs. 3, 31)
 - “CALL” appears when call channel is selected.
- Push for 3 sec. to enter call channel programming condition when call channel is selected. (pgs. 7, 32)
- While pushing [H/L], enters memory name programming condition. (pgs. 7, 35)
- Enters set mode when pushed and hold [16•9] turning the power ON. (pgs. 20, 34)

10 HM-127 REMOTE-CONTROL MICROPHONE

5 CHANNEL/DUALWATCH/TRI-WATCH SWITCH

[CH/WX•DW•U/I/C]

- ➔ Selects and toggles the regular channels and weather channel when pushed momentarily. (pgs. 5, 31)
- ➔ While pushing [H/L], selects one of 3 regular channels in sequence when pushed. (pgs. 5, 31)
 - International, U.S.A. and Canadian channels are available for regular channels.
- ➔ Starts dualwatch or tri-watch when pushed for 1 sec. (pgs. 8, 33)
- ➔ Stops dualwatch or tri-watch when either is activated.

6 ATTENUATOR/INTERCOM/SCRAMBLER SWITCH

[LO/DX•IC•SCR]

- ➔ Activates the intercom function when pushed for 1 sec. (pgs. 19, 34)
 - Calls the IC-M402 when pushed and held while in intercom mode.

NOTE: RF attenuator and voice scrambler are not available for IC-M402.

7 SQUELCH/MONITOR/LOCK SWITCH [SQL•MONI•L]

- ➔ [▲]/[▼] sets the squelch threshold level after pushing [SQL]. (p. 29)
- ➔ Push [SQL•MONI] for 1 sec. to turn the monitor function ON. (p. 32)
- ➔ While pushing [H/L], push [SQL•MONI•L] to toggle the microphone key lock function ON or OFF. (p. 30)
 - “**L**” appears while key lock function is in use.

- [PWR], [PTT], [VOL], [SQL] and [H/L] still function when the microphone key lock function is turned ON.

- ➔ Advance the cursor while in memory name programming condition. (pgs. 7, 35)

8 VOLUME/DIMMER SWITCH [VOL•DIM]

- ➔ [▲]/[▼] adjusts the audio level after pushing [VOL].
- ➔ Push [VOL•DIM] for 1 sec. to adjust the brightness of the LCD and switch backlight. (p. 32)
- ➔ Move the cursor backward while in memory name programming condition. (pgs. 7, 35)

9 TRANSMIT POWER SWITCH [H/L]

- ➔ Toggles high and low power when pushed. (pgs. 6, 29)
 - Some channels are set to low power only.
- ➔ While pushing this switch, other switches perform secondary functions.
- ➔ Toggles the all key lock function ON or OFF when pushed while turning power ON. (p. 30)
 - “**L**” flashes while the all key lock function is in use.
 - Only [PWR] and [PTT] function when the all key lock function is in use.

10 SCAN SWITCH [SCN•TAG] (pgs. 9, 33)

- ➔ Starts and stops normal or priority scan when tag channels are programmed.
- ➔ Push [SCN•TAG] for 1 sec. to set the displayed channel as a tag (scanned) channel.
- ➔ While pushing [H/L], push for 3 sec. to clear all tag channels.

■ Function display

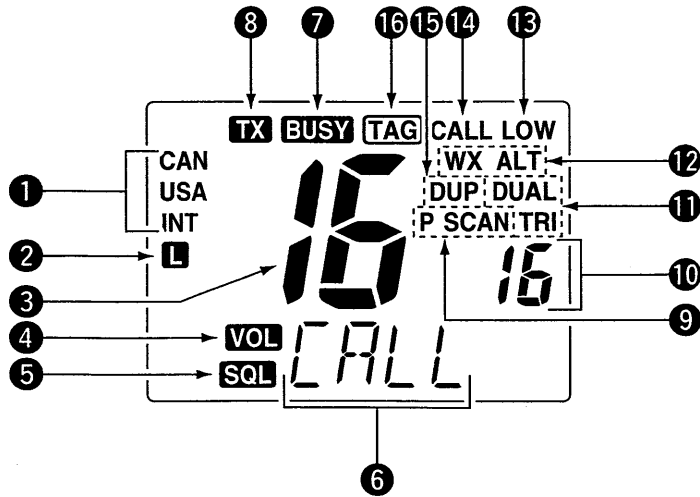

- 1 CHANNEL GROUP INDICATOR** (pgs. 6, 31)
Indicates whether an International (INT), U.S.A. (USA) or Canadian (CAN) channel is selected.
- 2 KEY LOCK INDICATOR** (p. 30)
 - ➔ Appears while the key lock function is in use.
 - ➔ Flashes while the all key lock function is in use.
- 3 CHANNEL NUMBER READOUT**
 - ➔ Indicates the selected operating channel number. "A" appears when a simplex channel is selected. (p. 5)
 - ➔ In set mode, indicates the selected condition. (pgs. 20, 34)

- 4 VOLUME INDICATOR** (p. 29)
Appears while audio output level is adjusted.
- 5 SQUELCH INDICATOR** (p. 29)
Appears while noise squelch level is adjusted.
- 6 CHANNEL NAME INDICATOR**
 - ➔ Channel comment appears (and scrolls) if programmed. (pgs. 7, 35)
 - ➔ In set mode, indicates or scrolls the selected set mode item. (pgs. 20, 34)
- 7 BUSY INDICATOR** (pgs. 6, 29)
Appears when receiving a signal or when the squelch opens.
- 8 TRANSMIT INDICATOR** (pgs. 6, 30)
➔ Appears while transmitting.
- 9 SCAN INDICATOR** (pgs. 9, 33)
 - ➔ "SCAN" appears during normal scan.
 - ➔ "P SCAN" appears during priority scan.
- 10 PRIORITY CHANNEL INDICATOR**
 - ➔ Indicates a priority channel number during priority scan or dual/tri-watch. (p. 8)
 - ➔ "IC" appears during intercom mode. (pgs. 19, 34)
- 11 DUAL/TRI WATCH INDICATOR** (pgs. 8, 33)
"DUAL" appears during dualwatch; "TRI" during tri-watch.

10 HM-127 REMOTE-CONTROL MICROPHONE

12 WEATHER CHANNEL INDICATOR (pgs. 6, 31)

- ➔ “WX” appears when a weather channel is selected.
- ➔ “ALT” appears when the weather alert function is in use; flashes when an alert tone is received.

13 LOW POWER INDICATOR (pgs. 6, 29)

Appears when low power is selected.

14 CALL CHANNEL INDICATOR (pgs. 5, 31)

Appears when the call channel is selected.

15 DUPLEX INDICATOR (p. 5)

Appears when a duplex channel is selected.

16 TAG CHANNEL INDICATOR (pgs. 10, 33)

Appears when a tag channel is selected.

■ Receiving and transmitting

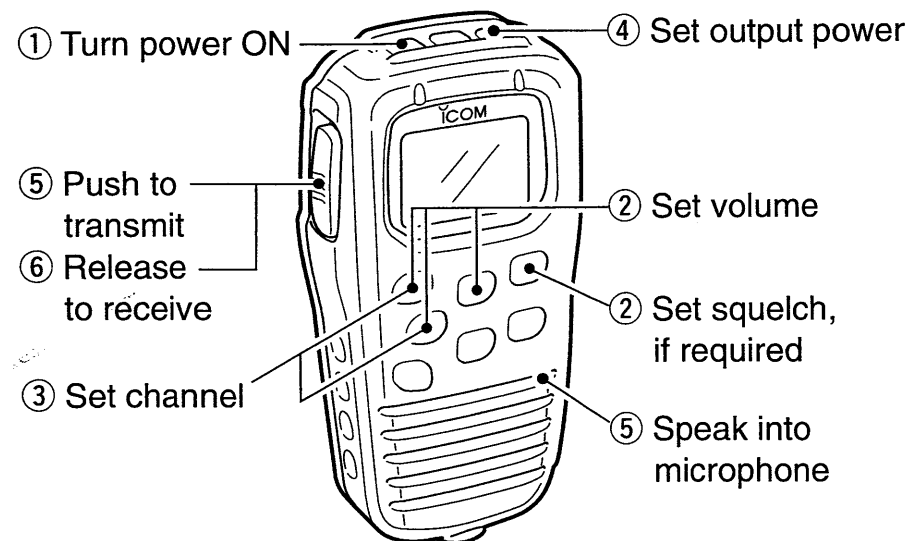

- ① Push [PWR] to turn power ON.
- ② Push [VOL], then [▲]/[▼] to adjust audio output level.
 - Push [SQL], then [▲]/[▼] to mute any audio noise, if necessary.
- ③ Push [▲]/[▼] to select the desired channel.
 - When receiving a signal, “**BUSY**” appears and audio is emitted from the speaker.
 - Further adjustment of audio level may be necessary at this point.
- ④ Push [H/L] to select the output power, if necessary.
 - “LOW” appears when low power is selected.
 - Choose low power for shorter, high power for longer distance communications.
 - Some channels are low power only.

⑤ Push and hold [PTT] to transmit, then speak into the microphone.

- “TX” appears.
- Ch 70 cannot be used for transmission (for GMDSS use).

Simplex channels, 3, 21, 23, 61, 64, 81, 82 and 83 **CANNOT** be lawfully used by the general public in U.S.A. waters.

⑥ Release [PTT] to receive.

IMPORTANT: To maximize the readability of your transmitted signal (voice), pause a few sec. after pushing [PTT], hold the microphone 2 to 5 cm (1 to 2 inches) from your mouth and speak at a normal voice level.

- Tri-watch becomes dualwatch when receiving a signal on the call channel.

Lock functions

The lock function electronically locks keys and switches to prevent accidental changes and function access from the microphone.

- All keys, switches and controllers on the transceiver are functional.

Microphone key lock function

➔ Push [SQL] while pushing [H/L] to turn the lock function ON and OFF.

- “L” appears.
- Only [PWR], [PTT], [H/L], [SQL•MONI], [VOL]+[▲]/[▼] and [SQL]+[▲]/[▼] are functional.

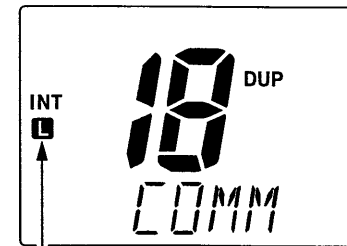

Appears when the microphone lock function is in use.

All key lock function

➔ Turn the power ON by pushing [PWR] while pushing [H/L] to turn the all key lock function ON and OFF.

- “L” flashes.
- Only [PWR] and [PTT] are functional.

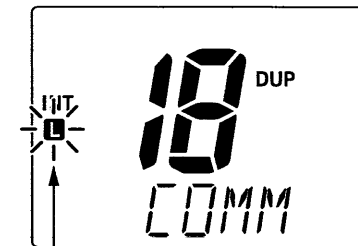

Flashes when the all lock function is in use.

Channel selection

◆ Channel 16

- ① Push [16] to select Ch 16.
- ② Push [CH/WX] to return to the condition before selecting Channel 16, or push [▲] or [▼] to select operating channel.

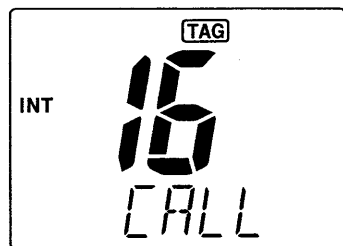

Push 

◆ Call channel

- ① Push [16•9] for 1 sec. to select call channel.
- ② Push [CH/WX] to return to the condition before selecting call channel, or push [▲] or [▼] to select operating channel.

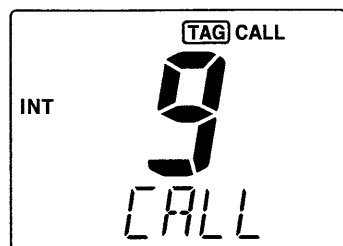

Push  for 1 sec.

◆ Weather channels

- ① Push [CH/WX] once or twice to select weather channel group.
- ② Push [▲] or [▼] to select weather channel.
- ③ Push [CH/WX] to return to the condition before selecting the weather channel group.

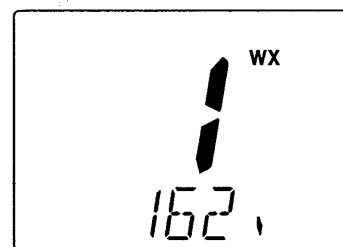

Push 

◆ U.S.A., International and Canadian channels

- ① Push [CH/WX] to select regular channel.
 - Push [CH/WX] again, if weather channel appears.
- ② Push [CH/WX] again, if weather channel appears.
 - U.S.A., International and Canadian channels can be selected in sequence.

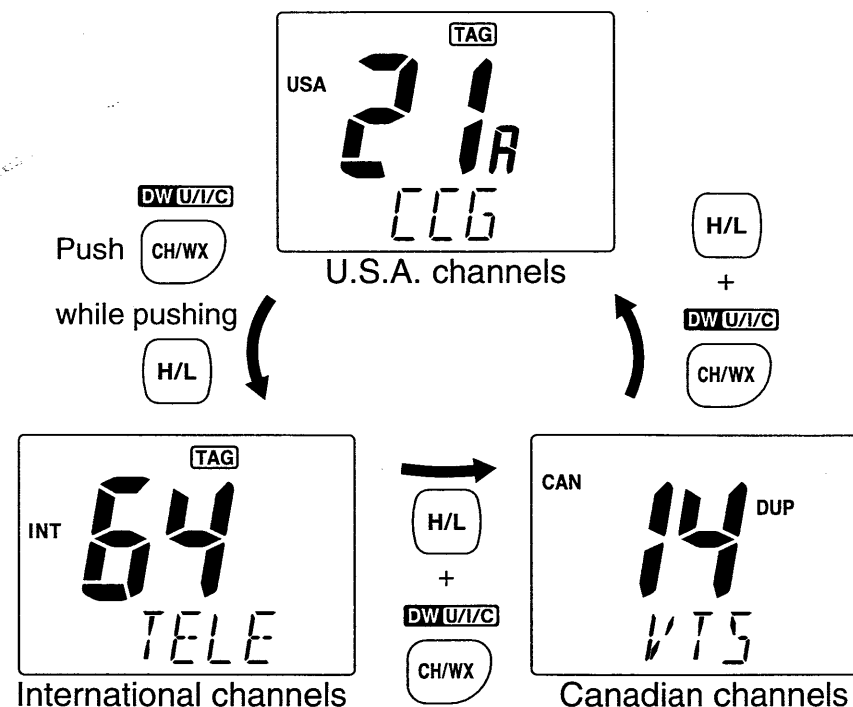

■ Display backlighting

The function display and switches can be backlit for better visibility under low light conditions. And the backlighting condition can be adjusted independently from the transceiver.

- ① Push [VOL•DIM] for 1 sec. to enter backlight adjusting mode.
 - “DIM” with number of backlight level appears in the channel name indicator.
- ② Push [▲]/[▼] to adjust the backlight level.
 - The backlight level is adjustable between 0 (lights OFF) and 7 (brightest).

For your reference:

While push and hold [H/L] push [▲] or [▼] also adjusts backlight level.

- No backlight level indication is available.

■ Monitor function

The monitor function releases the noise squelch mute of the microphone only. (An independent noise squelch system is employed.)

- ➔ Push [SQL•MONI] for 1 sec. to activate the monitor function.
 - “**BUSY**” flashes and audio is emitted.
 - Any key, except [▲]/[▼], cancels the monitor function.

■ Call channel programming

- ① Push [CH/WX•U/I/C] several times while pushing [H/L] to select the desired channel group (USA, INT, CAN) to be programmed.

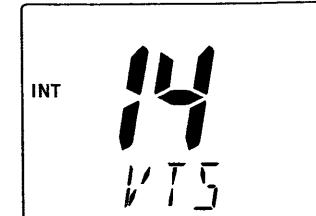

- ② Push [16•9] for 1 sec. to select the call channel of the selected channel group.
 - “CALL” and call channel number appear.

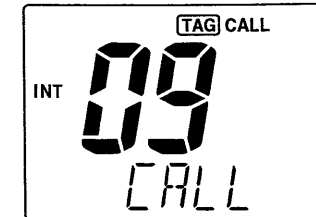

- ③ Push [16•9] again for 3 sec. (until long beep changes to 2 short beeps) to enter call channel programming condition.
 - Call channel number and channel group to be programmed flashes.

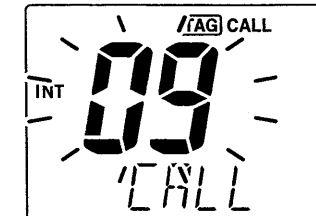

- ④ Push [▲]/[▼] to select the desired channel.

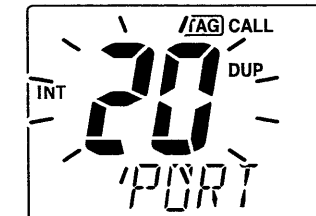

- ⑤ Push [16•9] to program the displayed channel as the call channel.
 - The call channel number and channel group stop flashing.

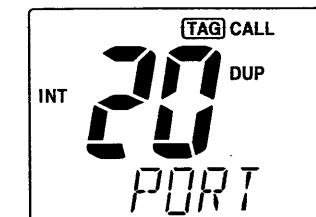

■ Starting a scan

- ① Push [CH/WX•U/I/C] several times while pushing [H/L] to select the channel group (USA, INT, CAN), if desired.
 - When the weather alert function is in use, select the desired weather channel with [CH/WX] and [▲]/[▼].
- ② Push [SCN] to start priority or normal scan.
 - “SCAN” appears during normal scan.
 - The priority channel readout indicates “16”, and “P” and “SCAN” indicators appear during priority scan.
 - When a signal is received, scan pauses until the signal disappears or resumes after pausing 5 sec. according to set mode setting (Ch 16 is still monitored during priority scan).
 - Push [▲]/[▼] to check the scanning tag channels, to change the scanning direction or resume the scan manually.
- ③ To stop the scan, push [SCN].
 - “SCAN” disappears.
 - Pushing [PTT], [16•9] or [CH/WX] also stops the scan.

■ Setting tag channels

- ① Push [CH/WX•U/I/C] several times while pushing [H/L] to select the channel group (USA, INT, CAN), if desired.
- ② Push [▲]/[▼] to select the desired channel to set as a tag channel.
- ③ Push [SCN•TAG] for 1 sec. to set the displayed channel as a tag channel.
 - “TAG” appears.

- ④ To cancel the tag channel setting, push and hold [SCAN•TAG] for 1 sec.
 - “TAG” disappears.

•Clearing all tag channels in the selected channel group

- ➔ While pushing [▲] and [▼], Turn power ON to clear all tag channels in the channel group.

■ Dualwatch/Tri-watch operation

- ① Push [▲]/[▼] to select the desired channel.
 - Push [CH/WX•U/I/C] several times while pushing [H/L] to select the channel group (USA, INT, CAN), if desired.
- ② Push [CH/WX•DW] for 1 sec. to start dualwatch or tri-watch.
 - “DUAL” appears during dualwatch; “TRI” appears during tri-watch.
 - Beep tone sounds when a signal is received on Channel 16.
 - Tri-watch becomes dualwatch when receiving a signal on the call channel.
- ③ To cancel dualwatch/tri-watch, push [CH/WX•DW] again.

■ Set mode programming

Set mode is used to change the condition of the transceiver's functions and the microphone's own functions:

In this section, instructions are for the microphone's own functions only. Refer p. 30–33 for the setting of the other functions. (Some functions may not be selected from the microphone.)

◆ Entering set mode

- ① Turn power OFF.
- ② While pushing [16•9], turn power ON.
 - After beep emission, a set mode item (in the channel name indicator and condition in the channel number readout) is displayed.
- ③ Push [16•9] to select the desired item, if necessary.
- ④ Push [▲]/[▼] to select the desired condition of the item.
- ⑤ Turn power OFF, then ON to exit set mode.

• Beep tone "BEEP"

- ➔ Push [▲] to turn ON, [▼] to turn OFF the beep output.

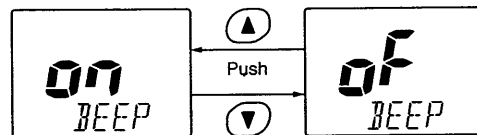

• LCD contrast "LCD CONTRAST"

- ➔ Push [▲]/[▼] to adjust to a suitable LCD contrast.

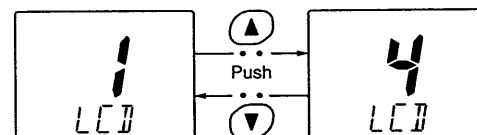

■ Intercom operation

- ① Push [LO/DX•IC] for 1 sec. to activate the intercom function.
 - "IC" appears in the priority channel readout.
 - The channel name disappears.
- ② Push [PTT] to talk.
 - "TALK" appears in the channel name indicator.
- ③ Release [PTT] to listen.
 - "LISTN" appears in the channel name indicator when the transceiver is in talking mode.
- ④ Push [LO/DX•IC] to cancel the intercom function.
 - Pushing [16], [SCN•TAG] or [CH/WX] is also cancels the intercom function.

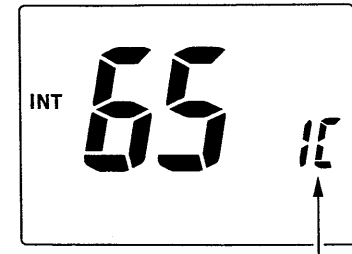

Appears when the intercom function is in use.

For your reference:

In case the intercom mode is selected with the transceiver during microphone power OFF, the microphone power is automatically turned ON and the intercom mode is selected.

◆ Intercom beep function

- ➔ Push [LO/DX•IC] for more than 1 sec.
- Emits intercom beep while holding.

■ Channel names

- ① Push [▲]/[▼] to select a channel to program.
 - Push [CH/WX•U/I/C] several times while pushing [H/L] to select the channel group (USA, INT, CAN), if desired.
- ② While push and hold [H/L] push [16•9].
 - The 1st character of the currently programmed comment flashes.
- ③ Push [▲]/[▼] to select a character.
- ④ Push [SQL] to move to right; then push [▲]/[▼] to select a character.
 - Push [VOL] to move to the left.
- ⑤ Continue until the desired characters have been selected, then push [16•9] to return to normal operation.

• Available characters

| | | | | | | | | | |
|---------|-------|-------|--------|---------|-------|-------|-------|--------|-------|
| (space) | ! (!) | " (") | # (#) | \$ (\$) | % (%) | & (&) | ' (') | ((()) |) ()) |
| * (*) | + (+) | , (,) | -- (—) | \ (.) | / (/) | 0 (0) | 1 (1) | 2 (2) | 3 (3) |
| 4 (4) | 5 (5) | 6 (6) | 7 (7) | 8 (8) | 9 (9) | A (A) | B (B) | C (C) | D (D) |
| E (E) | F (F) | G (G) | H (H) | I (I) | J (J) | K (K) | L (L) | M (M) | N (N) |
| O (O) | P (P) | Q (Q) | R (R) | S (S) | T (T) | U (U) | V (V) | W (W) | X (X) |
| Y (Y) | Z (Z) | a (a) | b (b) | c (c) | d (d) | e (e) | f (f) | g (g) | h (h) |
| i (i) | j (j) | k (k) | l (l) | m (m) | n (n) | o (o) | p (p) | q (q) | r (r) |
| s (s) | t (t) | u (u) | v (v) | w (w) | x (x) | y (y) | z (z) | | |

■ HM-127 supplied accessories

- Accessories included with the HM-127:**
- | | Qty. |
|---|-------------|
| ① Connection cable (OPC-1000: 6 m; 20 ft) | 1 |
| ② Mounting base | 1 |
| ③ Microphone hanger | 1 |
| ④ Screws (M3 × 16; tapping) | 5 |

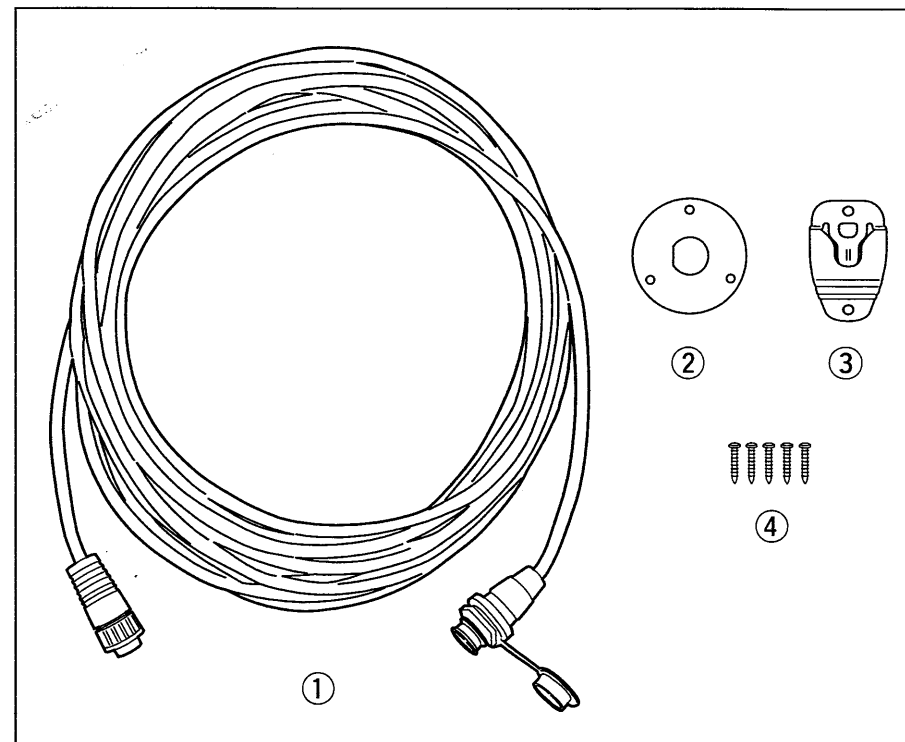

■ Installation

The optional HM-127 can be connected to the IC-M402 directly, as well as via the supplied connection cable for longer distance remote operation. The connector of the connection cable can be installed into a cabinet, wall, etc., as a built-in plug.

For longer distance remote operation, the optional extension cable, OPC-999 (6 m; 20 ft/Connecting between transceiver and the connection cable.), is available, and up to 2 OPC-999 can be added.

- ① Insert the supplied cable into the external microphone jack and tighten the cable nut as shown below.

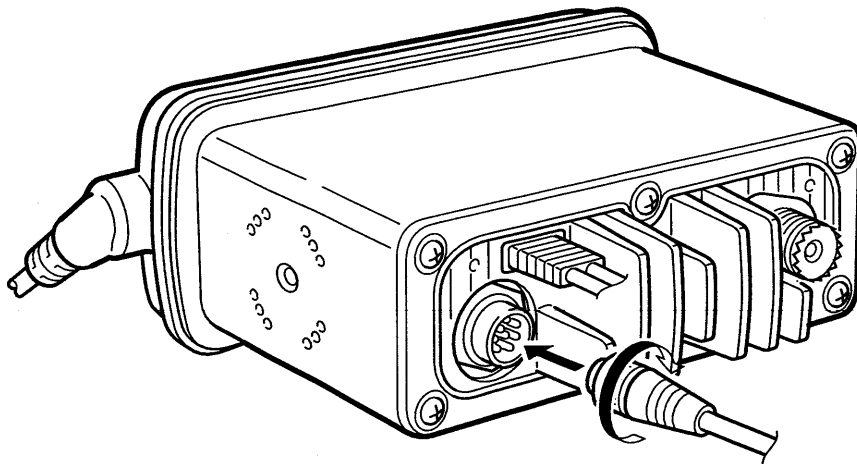

- ② To use the supplied cable as a wall socket, follow the following steps.
- ③ Using the mounting base, carefully mark off the 2 spots where the cable and screws will be fastened.
- ④ Drill holes at these marks.
- ⑤ Install the mounting base using screws as shown below.

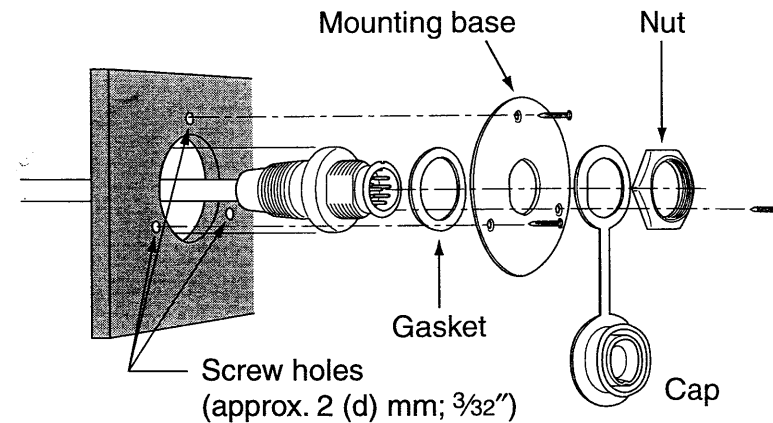

- ⑥ The installation is finished when it is completed.

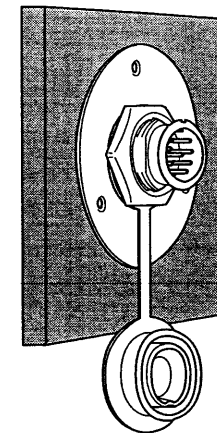

10 HM-127 REMOTE-CONTROL MICROPHONE

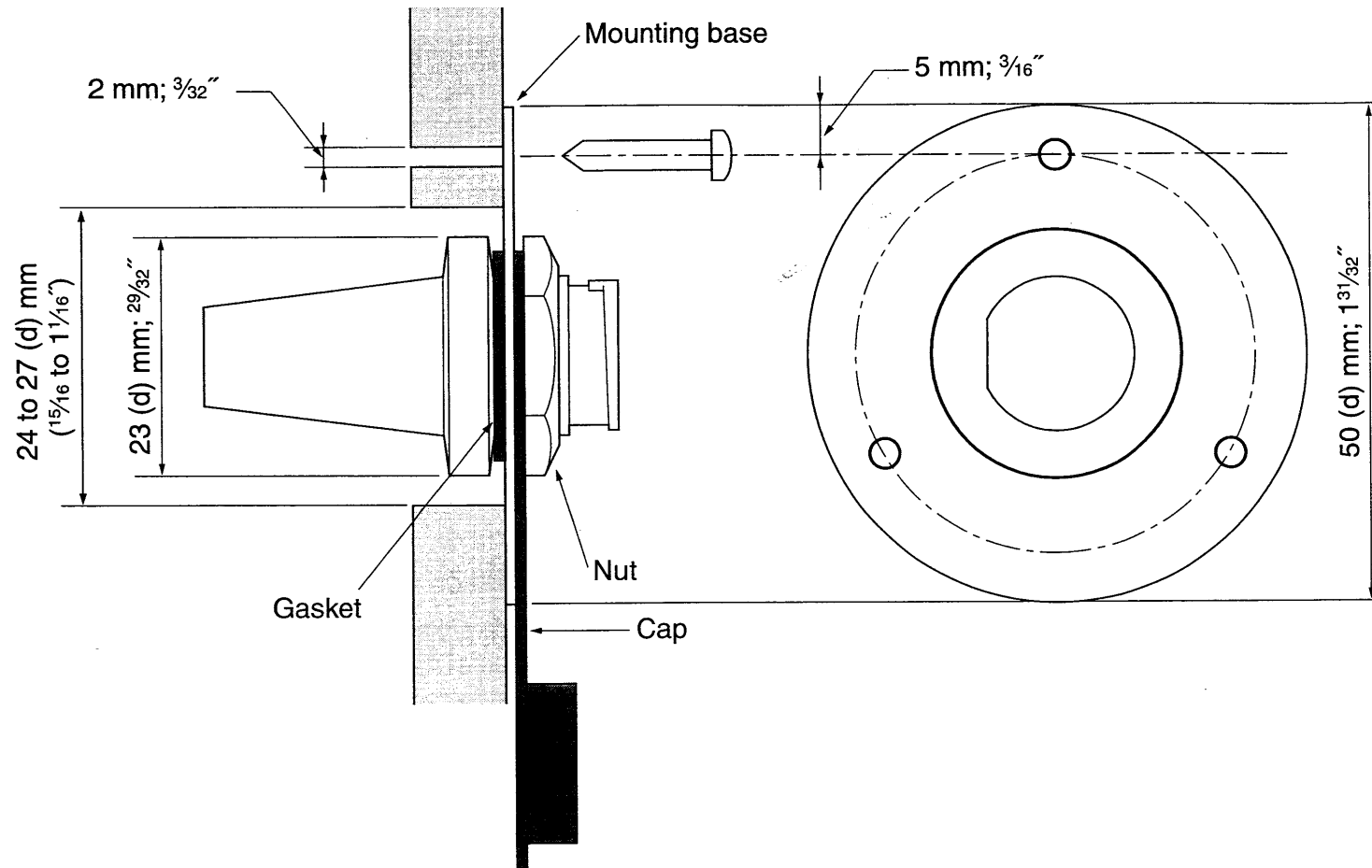

| PROBLEM | POSSIBLE CAUSE | SOLUTION | REF. |
|---|---|---|-----------------------|
| No power comes ON. | <ul style="list-style-type: none"> •Bad connection to the power supply. | <ul style="list-style-type: none"> •Check the connection to the transceiver. | p. 23 |
| No sound comes from the speaker. | <ul style="list-style-type: none"> •Squelch level is too deep. •Volume level is too low. •Speaker has been exposed to water. | <ul style="list-style-type: none"> •Set [SQL] to the threshold point. •Set [VOL] to a suitable level. •Drain water from the speaker. | p. 6 p. 6 |
| Transmitting is impossible, or high power cannot be selected. | <ul style="list-style-type: none"> •Some channels are for low power or receive only. •The output power is set to low. | <ul style="list-style-type: none"> •Change channels. •Push [H/L] to select high power. | pgs. 6 ,26 p. 6 |
| Scan does not start. | <ul style="list-style-type: none"> •TAG channel is not programmed. | <ul style="list-style-type: none"> •Set the desired channels as TAG channels. | p. 9 |
| No beep sounds. | <ul style="list-style-type: none"> •Beep tone is turned OFF. •The squelch is open. | <ul style="list-style-type: none"> •Turn the beep tone ON in set mode. •Set squelch to the threshold point. | p. 21 p. 6 |
| Distress call cannot be transmitted. | <ul style="list-style-type: none"> •MMSI (DSC self ID) code is not programmed. | <ul style="list-style-type: none"> •Program the MMSI (DSC self ID) code. | p. 11 |

12 CHANNEL LIST

| Channel number | | | Frequency (MHz) | |
|-----------------|-----------------|-----------------|-----------------|---------|
| USA | INT | CAN | Transmit | Receive |
| | 01 | 01 | 156.050 | 160.650 |
| 01A | | | 156.050 | 156.050 |
| | 02 | 02 | 156.100 | 160.700 |
| | 03 | 03 | 156.150 | 160.750 |
| 03A | | | 156.150 | 156.150 |
| | 04 | | 156.200 | 160.800 |
| | | 04A | 156.200 | 156.200 |
| | 05 | | 156.250 | 160.850 |
| 05A | | 05A | 156.250 | 156.250 |
| 06 | 06 | 06 | 156.300 | 156.300 |
| | 07 | | 156.350 | 160.950 |
| 07A | | 07A | 156.350 | 156.350 |
| 08 | 08 | 08 | 156.400 | 156.400 |
| 09 | 09 | 09 | 156.450 | 156.450 |
| 10 | 10 | 10 | 156.500 | 156.500 |
| 11 | 11 | 11 | 156.550 | 156.550 |
| 12 | 12 | 12 | 156.600 | 156.600 |
| 13 ² | 13 | 13 ¹ | 156.650 | 156.650 |
| 14 | 14 | 14 | 156.700 | 156.700 |
| 15 ² | 15 ¹ | 15 ¹ | 156.750 | 156.750 |
| 16 | 16 | 16 | 156.800 | 156.800 |
| 17 ¹ | 17 | 17 ¹ | 156.850 | 156.850 |
| | 18 | | 156.900 | 161.500 |
| 18A | | 18A | 156.900 | 156.900 |
| | 19 | | 156.950 | 161.550 |

| Channel number | | | Frequency (MHz) | |
|----------------|-----|-----------------|-----------------|---------|
| USA | INT | CAN | Transmit | Receive |
| 19A | | 19A | 156.950 | 156.950 |
| 20 | 20 | 20 ¹ | 157.000 | 161.600 |
| 20A | | | 157.000 | 157.000 |
| | 21 | 21 | 157.050 | 161.650 |
| 21A | | 21A | 157.050 | 157.050 |
| | | 21b | Rx only | 161.650 |
| | 22 | | 157.100 | 161.700 |
| 22A | | 22A | 157.100 | 157.100 |
| | 23 | 23 | 157.150 | 161.750 |
| 23A | | | 157.150 | 157.150 |
| 24 | 24 | 24 | 157.200 | 161.800 |
| 25 | 25 | 25 | 157.250 | 161.850 |
| | | 25b | Rx only | 161.850 |
| 26 | 26 | 26 | 157.300 | 161.900 |
| 27 | 27 | 27 | 157.350 | 161.950 |
| 28 | 28 | 28 | 157.400 | 162.000 |
| | | 28b | Rx only | 162.000 |
| | 60 | 60 | 156.025 | 160.625 |
| | 61 | | 156.075 | 160.675 |
| 61A | | 61A | 156.075 | 156.075 |
| | 62 | | 156.125 | 160.725 |
| | | 62A | 156.125 | 156.125 |
| | 63 | | 156.175 | 160.775 |
| 63A | | | 156.175 | 156.175 |
| | 64 | 64 | 156.225 | 160.825 |

| Channel number | | | Frequency (MHz) | |
|-----------------|-----------------|------------------|-----------------|---------|
| USA | INT | CAN | Transmit | Receive |
| 64A | | 64A | 156.225 | 160.825 |
| | 65 | | 156.275 | 160.875 |
| 65A | 65A | 65A | 156.275 | 156.275 |
| | 66 | | 156.325 | 160.925 |
| 66A | 66A | 66A ¹ | 156.325 | 156.325 |
| 67 ² | 67 | 67 | 156.375 | 156.375 |
| 68 | 68 | 68 | 156.425 | 156.425 |
| 69 | 69 | 69 | 156.475 | 156.475 |
| 70 ³ | 70 ³ | 70 ³ | 156.525 | 156.525 |
| 71 | 71 | 71 | 156.575 | 156.575 |
| 72 | 72 | 72 | 156.625 | 156.625 |
| 73 | 73 | 73 | 156.675 | 156.675 |
| 74 | 74 | 74 | 156.725 | 156.725 |
| 77 ¹ | 77 | 77 ¹ | 156.875 | 156.875 |
| | 78 | | 156.925 | 161.525 |
| 78A | | 78A | 156.925 | 156.925 |
| | 79 | | 156.975 | 161.575 |
| 79A | | 79A | 156.975 | 156.975 |
| | 80 | | 157.025 | 161.625 |
| 80A | | 80A | 157.025 | 157.025 |
| | 81 | | 157.075 | 161.675 |
| 81A | | 81A | 157.075 | 157.075 |
| | 82 | | 157.125 | 161.725 |
| 82A | | 82A | 157.125 | 157.125 |
| | 83 | 83 | 157.175 | 161.775 |

| Channel number | | | Frequency (MHz) | |
|----------------|-----|-----|-----------------|---------|
| USA | INT | CAN | Transmit | Receive |
| 83A | | 83A | 157.175 | 157.175 |
| | | 83b | Rx only | 161.775 |
| 84 | 84 | 84 | 157.225 | 161.825 |
| 84A | | | 157.225 | 157.225 |
| 85 | 85 | 85 | 157.275 | 161.875 |
| 85A | | | 157.275 | 157.275 |
| 86 | 86 | 86 | 157.325 | 161.925 |
| 86A | | | 157.325 | 157.325 |
| 87 | 87 | 87 | 157.375 | 161.975 |
| 87A | | | 157.375 | 157.375 |
| 88 | 88 | 88 | 157.425 | 162.025 |
| 88A | | | 157.425 | 157.425 |
| WX channel | | | Frequency (MHz) | |
| | | | Transmit | Receive |
| 1 | | | RX only | 162.550 |
| 2 | | | RX only | 162.400 |
| 3 | | | RX only | 162.475 |
| 4 | | | RX only | 162.425 |
| 5 | | | RX only | 162.450 |
| 6 | | | RX only | 162.500 |
| 7 | | | RX only | 162.525 |
| 8 | | | RX only | 161.650 |
| 9 | | | RX only | 161.775 |
| 10 | | | RX only | 163.275 |

¹Low power only. ²Momentary high power. ³Receive only.

NOTE: Simplex channels, 3, 21, 23, 61, 64, 81, 82 and 83 **CANNOT** be lawfully used by the general public in U.S.A. waters.

■ Specifications

◆ General

- Frequency coverage :
 - Transmit 156.025–157.425 MHz
 - Receive 156.050–163.275 MHz
- Mode : FM (16K0G3E)
DSC(16K0G2B)
- Channel spacing : 25 kHz
- Current drain (at 13.8 V) : Tx 6.0 A (at 25 W output).
Rx 1.2 A (at AF max.)
- Power supply requirement : 13.8 V DC \pm 15%
- Operating temperature range : -20°C to $+60^{\circ}\text{C}$; -4°F to $+140^{\circ}\text{F}$
- Dimensions : 153(W) \times 67(H) \times 141.6(D) mm
(Projection not included) $6^{1/32}$ (W) \times $2^{5/8}$ (H) \times $5^{9/16}$ (D) in
- Weight : 900 g ; 2 lb

◆ Transmitter

- Output power : High 25 W
Low 1 W
- Modulation system : Variable reactance frequency modulation
- Max. frequency deviation : \pm 5.0 kHz
- Spurious emissions : Less than -70 dB

◆ Receiver

- Receive system : Double conversion
superheterodyne
- Sensitivity (12 dB SINAD) : $0.25\mu\text{V}$
- Squelch sensitivity : $0.20\mu\text{V}$ (typical)
- Intermodulation rejection ratio : 70 dB
- Spurious response rejection ratio : 70 dB
- Adjacent channel selectivity : 70 dB
- Audio output power : 4.5W (typical) at 10% distortion with
a 4 Ω load
- GPS interface : NMEA0183 ver.2.0

All stated specifications are subject to change without notice or obligation.

13 SPECIFICATIONS

■ Dimensions

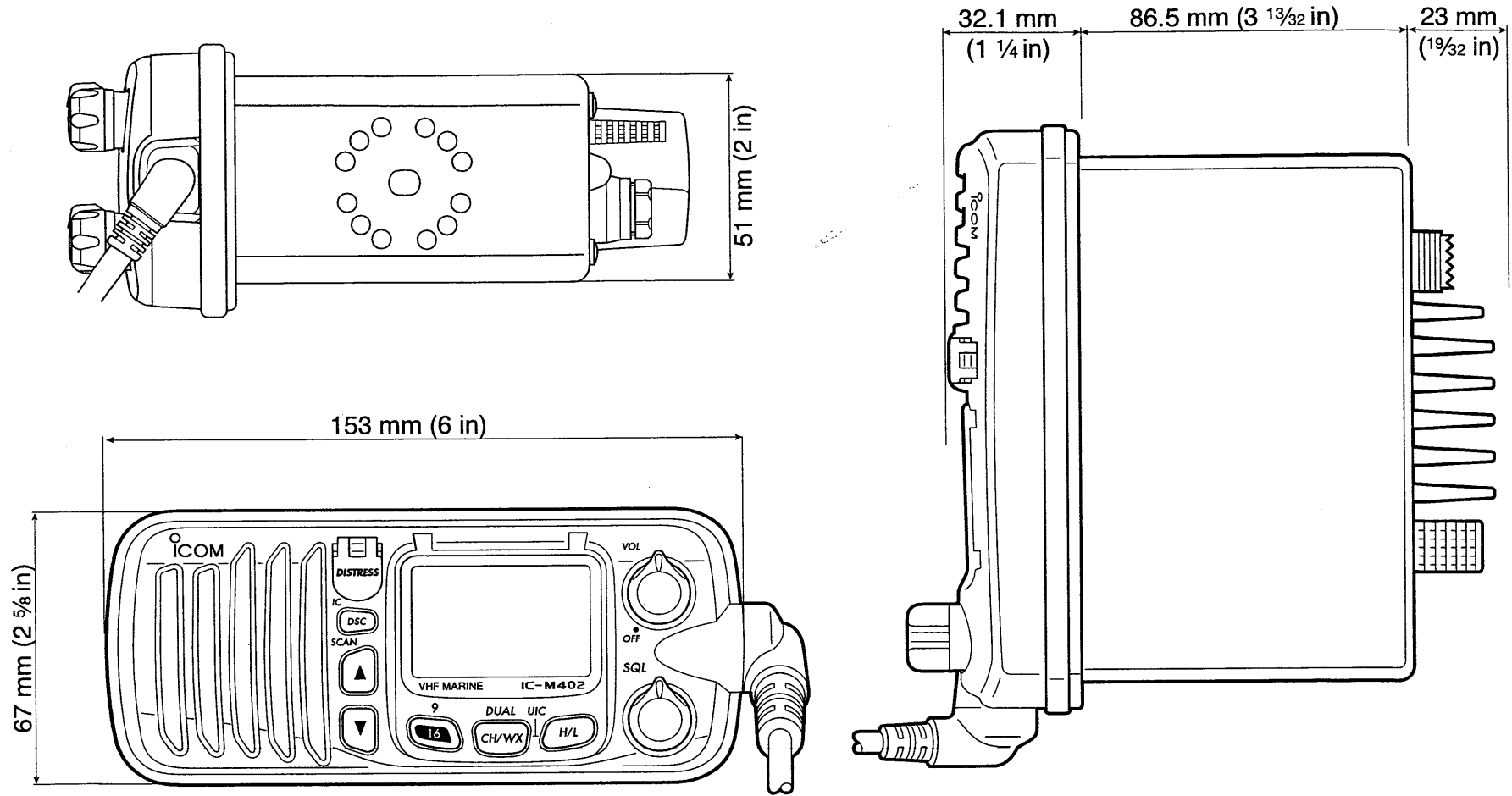

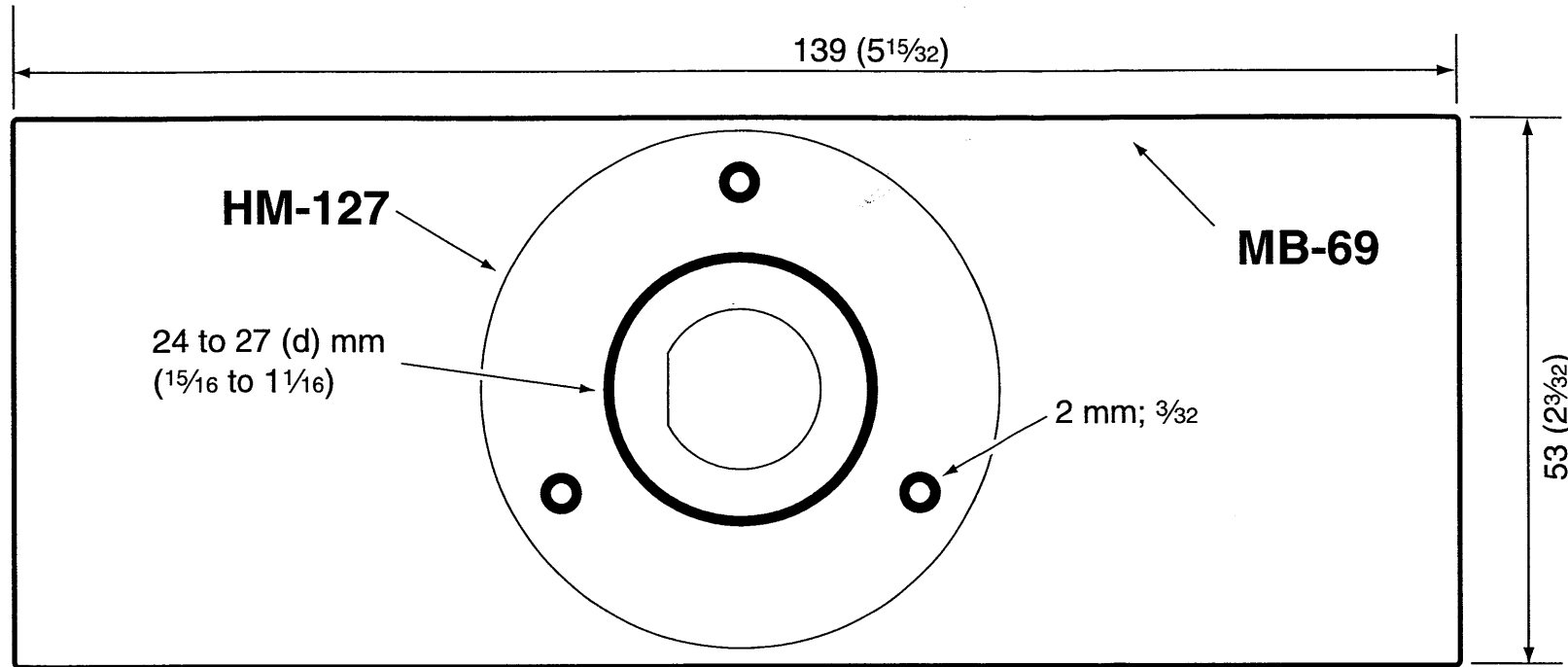

Unit: mm (inch)

■ Options

- **MB-69 FLUSH MOUNT KIT**

For mounting the transceiver to a panel.

- **SP-5 EXTERNAL SPEAKER**

A large, external speaker for superior audio output.

- **SP-10 EXTERNAL SPEAKER**

A compact, external speaker. Features easy installation.

- **HM-127* REMOTE-CONTROL MICROPHONE (p. 30)**

External microphone-type controller. Provides optional intercom operation. 6 m (20 feet) microphone cable and mounting base included. Black and white colours are available.

*IC-M402 only

- **OPC-999* MICROPHONE EXTENSION CABLE**

6 m (20 feet) microphone extension cable for optional HM-127. Up to 2 OPC-999 can be connected. (18 m; 60 feet maximum)

*IC-M402 only

Count on us!

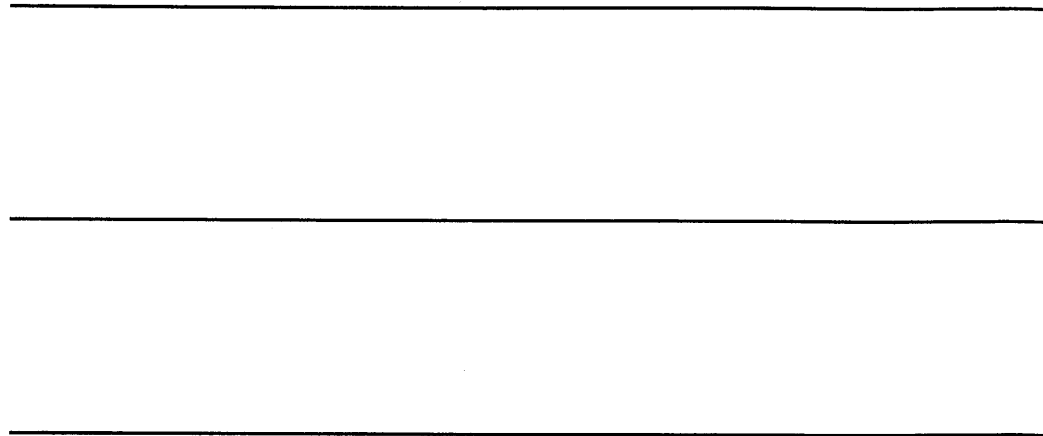
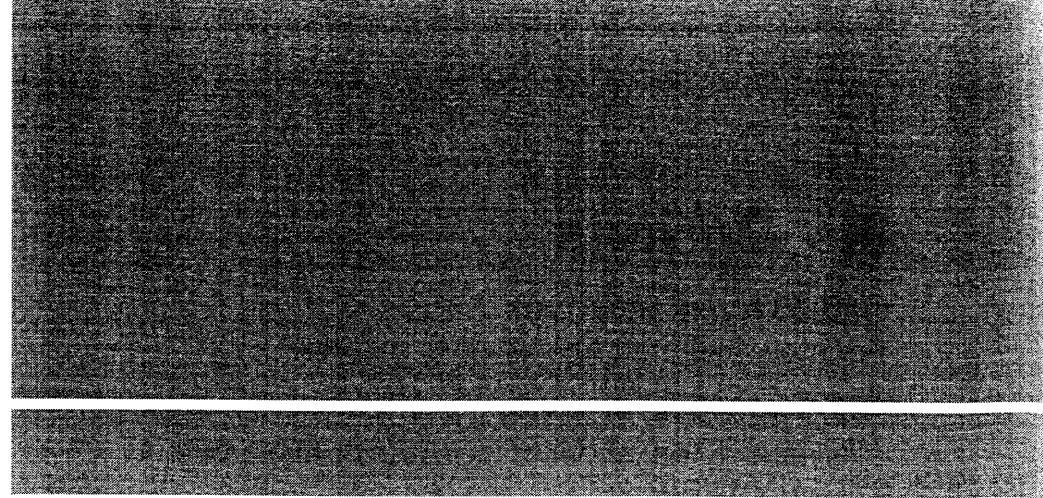

A-6137H-1US-①
Printed in Japan
© 2002 Icom Inc.

Icom Inc.
1-1-32 Kamiminami, Hirano-ku, Osaka 547-0003 Japan